

Blaser

TRADITIONS
OF
TOMORROW



TRADITIONS OF TOMORROW





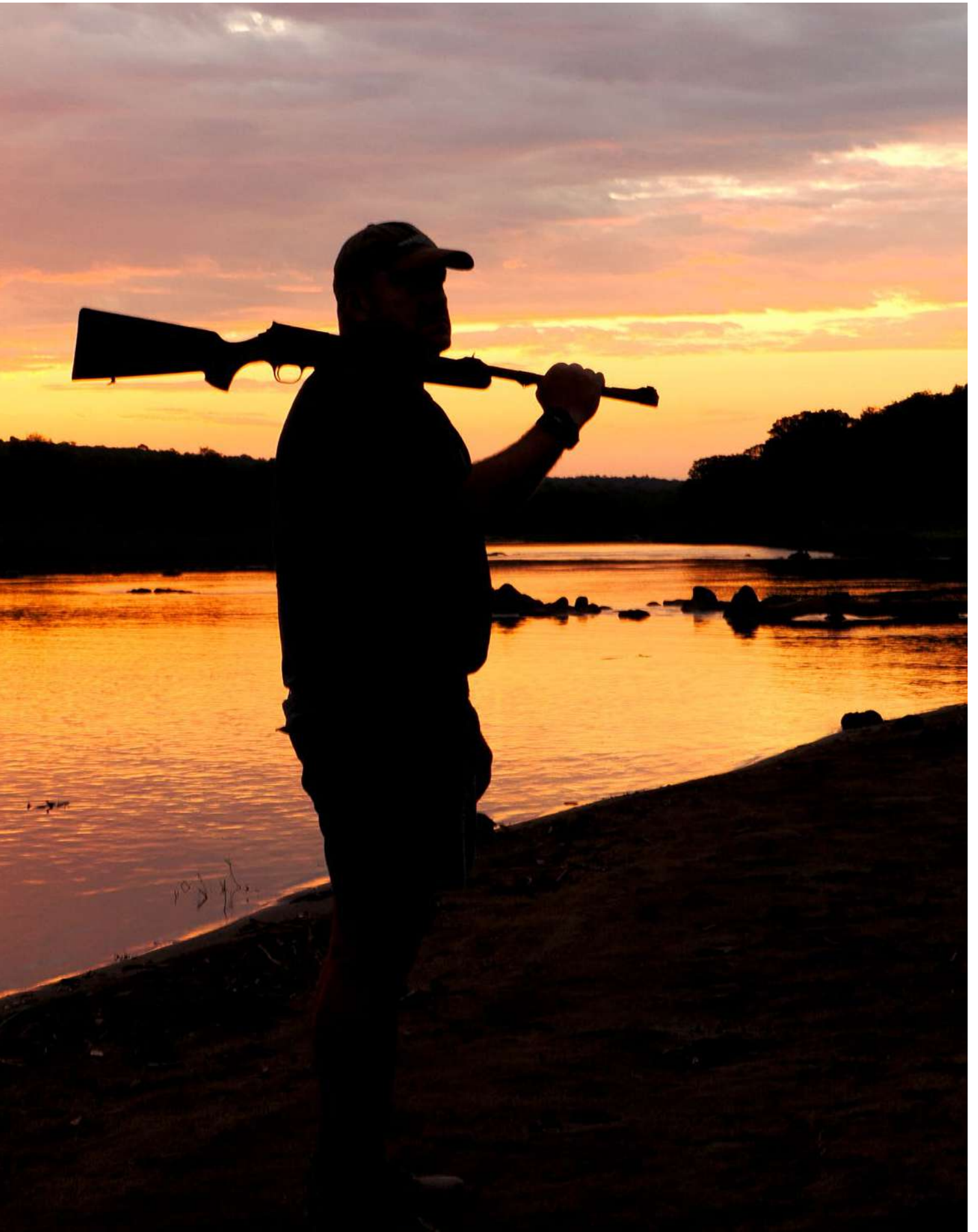

HUNTING IS LIFE!



Do you agree wholeheartedly with this challenging creed? As hunters, we perceive hunting as a deeply felt passion that is based on a fundamental, multi-faceted philosophy of life. The focus is not only on the success of a hunt, but rather on intensely experiencing nature with all our senses. It is all about forging a close link between humans and our environment and about taking responsibility for the flora and fauna – sustainably and in line with traditional hunting ethics.

My name is Tanja Kantauer. My viewpoint has evolved in this direction since I became part of the Blaser Safaris team 14 years ago and because I am a hunter myself. My mentor and predecessor Rainer Schwarz, from whom I took over the management one year ago, played a crucial role in this. Now, for the first time, a woman is at the helm of our hunting travel agency.

In line with the Blaser Group, we are invested in combining unique experiences with responsible hunting that complies with animal conservation. Although hunting abroad is often criticized, it significantly supports the protection of endangered species and is therefore conservation put into practice. We ensure this by offering selected destinations that we are familiar with and by working with reliable local partners across the globe who share our sense of responsibility.

This responsibility for resources and a “fair chase” approach is also reflected in the new and enhanced products across our entire product range – in combination with our optics, we have designed and engineered our firearms to unrivaled uncompromising precision, because only a precise shot means ethical hunting.

Blaser stands for the continuous optimization of all products in the portfolio and develops them into indispensable hunting companions worldwide. Blaser clothing offers maximum functionality and is unique in the hunting sector. Our accessories and equipment are based on the specific needs of our customers from worldwide hunting practice.

With this in mind, I hope you enjoy our new catalog and wish you a successful hunt!

Sincerely

A handwritten signature in black ink that reads "Tanja Kantauer". The signature is written in a cursive, flowing style.

Tanja Kantauer
CEO of Blaser Safaris GmbH

EVERYTHING BLASER. EVERYTHING FROM A SINGLE SOURCE.

As a full-range provider in the field of hunting, we offer you a perfectly coordinated system of Blaser hunting rifles and shotguns, Blaser riflescopes, Blaser ammunition, Blaser clothing, and Blaser accessories as well as selected Blaser hunting trips.

12



RIFLE

R8 Bolt Action Rifle

Unique in every way.

- 18 R8 Ultimate
 - 50 R8
 - 68 R8 Professional
 - 74 K95 Single Shot Rifles
- One shot. One hit.

- 28 Easy Custom
- 32 CustomTec

58

CUSTOM



148



OUTFITS

- 36 Field & Forest
Robust companions
- 86 HunTec
For extreme conditions
- 150 Competition
Made for competition
- 158 Classic
Hunt in style

70



ACCESSORIES

164

NEW



FBX
SIMPLY THE BEST

**AMMUNI-
TION**



92

104



OPTICS

- 114 B1
Uncompromisingly precise.
Superbly beautiful.
- 118 B2
Made for hunting

128

130



SHOTGUN

- 142 F3
Answers to the
highest demands
- 152 F16
Perfection from passion

**BLASER
SAFARIS**



170

Dream destinations all
over the world

NEW



RF 8x32
RF 10x42

OUR PASSION: HUNTING



From passion

Hunting is one of the oldest passions of humanity, and yet hunters constantly have to equip themselves for new challenges. That is only possible through innovation and the people who drive it with their passion.

From a deep bond

As a leading innovator, we are the driving force in the international hunting firearms industry. More than half a century of experience has sharpened our senses for practical technological progress. And we never lose sight of our ethical responsibilities.

From enthusiasm

While all Blaser employees share the same enthusiasm for hunting, we have a wide range of different talents. The diversity of personalities, the perfect interlinking of skills, and the joy in working together are the strongest ingredients in our recipe for success.

OUR OBJECTIVE: CREATING VALUES



From solid blanks

Manufacturing system parts from solid blanks ensures sound quality, reliability, and durability. Complex manufacturing on state-of-the-art CNC machines provides the basis for minimum tolerances and long-term shooting accuracy.

From high-quality materials

Whether highly tempered steel, forged light-metal alloys, or precious walnut – all materials are combined with artisan precision to create unique, valuable objects. Each Blaser hunting rifle and shotgun is an investment that will last for generations.

From a sense of tradition

We rely on traditional craftsmanship to make our mark on modern hunting practices. Highly qualified gunsmiths, stockmakers, and engravers turn the firearm into a masterpiece that underlines the personality and passion of its owner.



OUR CONCLUSION: EVERYTHING FROM A SINGLE SOURCE

Blaser has been shaped by enthusiasm for the manufacturing of hunting firearms and a passion for hunting. This has always resulted in excellent products and perfectly coordinated complete solutions that we are consistently expanding and enhancing. Because successful hunting needs much more than just an excellent firearm.

Helpful hunting optics

Creating the perfect unit of rifle and riflescope has always been our passion. For our own development division in Wetzlar, we brought together the best of their trade, resulting in unrivaled hunting optics. These are precisely the riflescopes and binoculars that we want to recommend to our customers.

Coordinated equipment

To us, “everything from a single source” also means: high-performance rifle ammunition, essential equipment that is indispensable for hunting, and premium clothing made for active hunting.

Attractive hunting experiences

On the hunting trips all over the world selected by Blaser, highly professional outfitters do everything to meet our customers’ quality requirements – for unforgettable hunting experiences.



Experience Blaser digitally

We are at your side not only during a hunt, but also online. Configure the rifle of your dreams on our **website**, choose your individual stock wood in the Blaser Stock Portal, or browse a selection of exquisite Blaser Custom rifles in the new “**Online Gun Room**”. Discover the world of Blaser in moving images on YouTube or use #blaserfamily to share your most beautiful Blaser moments on our social media channels. We look forward to seeing you!



SUSTAINABILITY

PASSION FOR *Nature*

As hunters, we feel an innate sense of responsibility for our natural habitat. This deeply felt conviction drives Blaser's dedication to engage in ways that take the deliberately chosen responsibility to preserve and protect nature and wildlife into account.

As key nature activists, hunters shape our cultural landscape. Their actions affect biodiversity and therefore our climate. To show the challenges we are facing, and the role hunters can play to overcome them, Blaser is supporting a film series by FieldSports Channel and deer expert, Niall Rowantree, that is taking a closer look at sika deer and their habitat in Scotland.





hunters come in. Ideally, we manage deer numbers in such a way that the different deer species can fulfill their role in the habitat, e.g. by maintaining a certain forest structure by their different grazing behavior.

So reforestation plays an important role in the carbon sequestration?

Of course, forests do store GHG and are important. However, with the peat bogs Scotland has a much more important habitat for carbon sequestration. They have been built up over thousands of years, forests rarely exceed 100 years. The Scottish peat bogs store more GHG than all the boreal forests on the European mainland. And the native red deer play a vital role in the maintenance of those peat bogs. Grazing keeps the plants such as heather healthy, thereby ensuring the functioning of a peat bog in the long run. We should keep that in mind, when discussing red deer numbers.

Why are hunters often criticized when they play such a vital part in restoring the balance of an ecosystem?

It shows a deep lack of understanding of who we are. We are living in a cultural landscape which is the result of individual or political decisions over the last centuries. If we want to reshape it to have a more viable future, hunters are predestinated to be part of that process. We have a pole position in that we are out in nature regularly and see changes firsthand. We must continue to communicate these changes, engage more people in our efforts and convince them that by having a balanced habitat which takes into account all wildlife, we are not only doing good for the climate but are also choosing the best way to produce low carbon, protein-rich, sustainable food.



Why dedicate four films to sika deer?

Because the situation we face in Scotland today combines many of the challenges we are facing all over the world: conservation, biodiversity, carbon sequestration and with it, climate change. Maybe even more important, it shows how intertwined those topics are and that there are, in fact, no right or wrong answers. However, each choice we make will have consequences for the whole habitat.

The sika deer pose a threat for biodiversity as well as for the reforestation in Scotland.

Why do sika deer pose a challenge from a conservationist point of view?

Because it is an alien species which has been, after they escaped the enclosures in the 1890s, so successful that they are threatening the native red deers in the competition for the best grazing grounds as well as by diluting the red deer gene pool by hybridization. Therefore, they pose a real threat to biodiversity as well as for reforestation efforts.

But in evolutionary terms, they are more successful?

Absolutely. But does it mean that we should simply leave them in place? Not from my point of view. The landscape in Scotland today has been heavily influenced by man and also shaped by its wildlife through grazing habits over the last centuries. And since sika deer grazes differently, they will automatically produce a very different landscape. If you want to go back to a more balanced ecosystem, or a more native environment as some people call it, it might be safer to rely on the familiar instead of betting on a new player, whether it is an animal or a plant. And that is where hunters enter the picture. Successful conservation is born out of good deer management.

Protecting red deer and their natural habitat is a matter close to Niall's heart.

But what exactly is the native environment?

That is the question. Do we really think it makes sense to reforest vast parts of Scotland? Keep in mind that if you opt for one kind of habitat you are trading the welfare of another habitat. Instead, a mosaic of habitats could be the better solution whenever possible as ecosystems have their greatest biodiversity where they meet. That also means leaving a certain number of deer in the habitat. Sure, that requires management, but it is where the





R8

UNIQUE IN EVERY WAY

The demands hunters place on their rifles are just as diverse as hunting. The R8 ingeniously combines all the features essential for hunting success in a unique package. In order to provide you with the best hunting rifle for your needs, it is our aim to continuously expand the R8 portfolio.



ACCURATE

Precision Trigger

The desmodromic trigger mechanism guarantees your trigger will function even when iced or heavily soiled. The mechanical advantage of a simple lever will ensure success even in the harshest conditions. When things are going your way a trigger without creep, will turn that thought impulse into action.

Saddle Mount

Barrel and Saddle Mount form one accurate unit: Notches machined into the top of the barrel, directly above the chamber, insure while your barrel freely floats your point of impact remains constant.

Optimum Barrel Bedding

The large-scale bedding of the barrel exclusively in the solid receiver guarantees repeatable accuracy when exchanging the barrel.

Radial Locking System

Stability and reliable accuracy: The extremely strong, concentric locking system locks directly in the barrel without any rotary motion.

Forged Barrel and Chamber

Precision and durability: The barrel and chamber are cold hammer forged. Barrel and chamber are perfectly concentric.

Perfect Stock Design

The relaxed shooting position of the hand reduces the risk of flinching. Blaser stocks, with their distinct palm swell and optimal cast, provide the ideal grip. The thumbhole stocks of the R8 Success and R8 Ultimate models go even further: thanks to a completely relaxed wrist and arm posture, shooting accuracy is significantly enhanced in any firing position.

SAFE

Manual Cocking System

For decades, Blaser's manual cocking system has set the benchmark. It is acknowledged as one of the safest in the world. There is no mechanical safety system that guarantees the safety of an uncocked firing spring. The R8 is cocked the very moment before shooting. Should the shot not be taken, by simply pressing down on the cocking lever, it will slide back smoothly, decocking the rifle.

Protection Against Misuse

If the R8 magazine with integrated trigger guard is taken out, the cocking lever cannot be set in the cocked position. This is without doubt the safest protection against unauthorized use!

No Unintentional Bolt Opening

If the R8 is decocked with a locked bolt, the bolt handle is blocked. To safely open the bolt, the cocking lever needs to be moved slightly forward (approx. 3 mm / 1/8"), but not cocked, while simultaneously pulling back on the bolt handle.

HUNTABLE

Short Cut

The unique design of the R8 magazine above the trigger allows the overall length of the R8 to be significantly shorter than any conventional bolt action rifle.

Perfect Balance

The well-balanced weight distribution offers fast handling and quick target acquisition.

Easy Take-Down

More comfort when stalking over long distances: the R8 can be stripped down, packed away and reassembled in a matter of seconds without the slightest change in the point of impact.



RELIABLE

Quick Take Down – Easily Cleaned

Even when in the bush, the R8 can be taken down and reassembled within a few seconds. Snow, dirt, leaves or needles are easily removed.

Desmodromic Trigger Mechanism

Maximum reliability – even when iced or heavily soiled. The trigger system of the R8 is force-controlled. Cycling the bolt automatically resets the trigger.

Locked Magazine

The R8 magazine is only released when simultaneously pressing both release buttons. Accidental drop out of the magazine by unintentionally pushing the release buttons is thus virtually impossible. In addition, both release buttons can be locked by a lever inside the magazine.

Excellent Protection

The closed construction of the R8 receiver prevents damage caused by foreign objects. When the magazine is stored outside the rifle, a protective cover keeps the dirt out. All metal parts are either made of rustproof material or protected against corrosion with a specific finish. The inside of the barrel and chamber are polished and need conventional care.



VERSATILE

Around the World with One Rifle

Trigger, stock length, and handling – everything remains just the way you are used to: Thanks to spare barrels, the R8 is the ideal companion on all continents no matter what game you are hunting.

Quick Scope Change

Every barrel is prepared for the Original Blaser Saddle Mount, so each scope or illuminated dot sight that is zeroed to the barrel can be interchanged.

Stock and Receiver Change as Required

If you are expecting bad weather or rugged terrain, the precious wooden stock can be removed and replaced with the durable synthetic stock of the R8 Ultimate and the corresponding receiver.

For Ladies

The R8 Intuition features a purpose-built stock which takes into account the anatomy of women.

For Left-Hand Shooters

Find all R8 models with optional left-hand stock and left-hand receiver in our online configurator.

FAST

In-line Repeating

Fast as lightning with a relaxed posture: The bolt handle is located in an ergonomically perfect position, just above the trigger guard. Rifle and eye remain focused on the target giving more time to aim exactly and ensure a perfect shot.

“Blind” Magazine Exchange

Easy and fast: The magazine buttons can be operated “blindly” due to their perfect positioning above the trigger. When pushing on both buttons at the same time, the magazine releases straight into the shooter’s hand. A second, loaded magazine can be inserted extremely quickly without looking.

Double Loading Option

The R8 can be loaded and unloaded in two ways: with the magazine taken out or left inside the rifle. With an open bolt, cartridges can be inserted or removed from the top of the magazine very quickly and easily.



R8 ULTIMATE

One rifle, countless possibilities: The R8 Ultimate sets a standard in terms of functionality and design. The two-piece ergonomically designed thumbhole stock ensures a completely relaxed shooting position, as well as optimal control of the rifle when firing. Thanks to modular stock options, the R8 Ultimate can be exactly tailored to your individual needs – and thus supports our goal: to provide what is needed to shoot better in every situation.



The R8 with left-handed stock and left-handed bolt assembly



Almost every model variant of the Blaser R8 is available as a true left-handed version with left-handed stock and left-handed bolt assembly. The ergonomic stock was developed especially for left-handed shooters. It is available as standard, Success or Ultimate stock in wood, carbon or as a synthetic version.

For shooters who would like to remain flexible: The R8 Professional provides a straight stock with double palmwell which is a suitable “ambidextrous” option for left- and right-handed shooters.



370 mm

1 | Recoil Absorption System

The inserted recoil pad with recoil absorption system makes for a pleasant shooting experience – even with larger calibers. The internal absorption elements are available in different hardness which can be adjusted to your preferences and produce a noticeably reduced muzzle climb while shooting. The recoil absorption system, especially in combination with the R8 Ultimate Silence or another silencer option, offers unmatched comfort while shooting.

2 | Adjustable Recoil Pad

The adjustable length, height and pitch of the recoil pad offers a variety of practical advantages. The length adjustment provides a memory function. The recoil pad can be adjusted quickly and easily for different shooters or, depending on weather, different clothing situations.



358-392 mm

3 | Compact Recoil Pad

The Compact recoil pad reduces the length of the Ultimate stock to only 350 mm. This allows the Ultimate models to be adapted even more individually to your own needs.



350 mm

4 | Adjustable Comb

The intuitively operated, multi-level adjustable comb ensures the perfect mount in every situation. Once the adjustable comb is fitted to your individual body proportions and your optics, the integrated memory function ensures return to the correct comb position for every shot.



Configure your R8 Ultimate!



R8 Ultimate

Choose between different stock options – with or without integral silencer – the modular system of the R8 Ultimate and R8 Ultimate Silence allows for a wide variety of optional configurations to suit your individual hunting requirements.

- Ergonomically optimized synthetic thumbhole stock
- Stock color black-brown with black elastomer inlays
- Prepared for adjustable comb, adjustable recoil pad, Compact recoil pad or recoil absorption system
- Optional leather inlays
- Optional barrel design Silence with integral silencer

ic illumination
CONTROL



Discover our entire portfolio
on www.blaser.de





Carbon is a high-tech composite material that is both light and very strong. During production, the individual carbon fiber layers are laid by hand in a mold until the required number of layers is reached. The stock is then hardened under temperature and pressure. Hunters appreciate the low weight and technical appearance of a carbon stock.



R8 Ultimate Carbon

This rifle is premier class: The R8 Ultimate Carbon represents another milestone in the evolution of the R8 bolt-action rifle.

- Ergonomically optimized thumbhole stock made of carbon
- Black elastomer inlays
- Available options include: adjustable comb, adjustable recoil pad, Compact recoil pad or recoil absorption system
- Optional leather inlays
- Optional barrel design Silence with integral silencer

ic illumination
CONTROL



Matching carbon rifle sling





R8 Ultimate HunTec Camo

We bring your equipment for active hunting in challenging terrain up to the next level: with the Blaser HunTec Camo. The camouflage pattern makes the R8 Ultimate HunTec Camo a master of disguise. In combination with the Blaser HunTec clothing and accessory line, it demonstrates its full strength.

- Ergonomically optimized thumbhole stock
- HunTec camo synthetic stock with black elastomer inlays
- Available options include: adjustable comb, adjustable recoil pad, Compact recoil pad or recoil absorption system
- Optional leather inlays
- Optional barrel design Silence with integral silencer

ic illumination
CONTROL



R8 Ultimate X

For the first time ever, a 10 round magazine complements the legendary bolt action rifle R8 with all its options. Training, competition, driven hunt – it is here where the R8 Ultimate X plays to its strengths.

- Ergonomically optimized thumbhole stock
- Magazine variants for standard and magnum calibers (10 rounds)
- Designed for insert magazines with increased capacity and existing magazine inserts
- Extended bolt handle
- Available options include: adjustable comb, adjustable recoil pad, Compact recoil pad or recoil absorption system
- Optional leather inlays
- Optional barrel design Silence with integral silencer

ic illumination
CONTROL



Discover our entire portfolio
on www.blaser.de





R8 Ultimate Silverstone

Speed, precision and design in the style of British understatement. First appearance at Silverstone: James Littlejohn, racing driver, driving coach, and member of the elite British Racing Drivers' Club, presents the R8 Ultimate Silverstone on the start-finish straight. Given his passion for classic sports cars and modern high-performance vehicles, the rifle has convinced the enthusiastic hunter at the shooting range and on the hunt.

Features

- Ultimate stock in black with adjustable comb
- Silver-gray receiver with matt brushed finish and Argali logo
- Fluted barrel profile including shortened barrel with muzzle thread
- Trigger, bolt handle ball and bolt in "diamond-like-carbon"
- Anthracite suede leather inlays with silver-gray contrast stitching
- Leather-covered recoil pad
- Pistol grip cap in silver-gray with "R8 Silverstone" lettering
- Optional barrel design Silence with integral silencer

ic illumination
CONTROL



EXCLUSIVELY IN SERIES.



R8 Ultimate Monza

Optimized performance comes first – even away from the race track. The R8 Ultimate Monza not only provides accurate shooting, but also captivates the imagination with its unusual design.

- Stock color black
- Impregnated leather inlays and recoil pad in black with red contrast stitching
- Black anodized aluminum stock inlay with red lettering
- Trigger guard, bolt handle ball and bolt head DLC coated
- Optional barrel design Silence with integral silencer

ic illumination
CONTROL





EASY CUSTOM



A PIECE OF INDIVIDUALITY

Original and easy – the Easy Custom range is your entry into the world of Blaser Custom engravings and embellishments. Give free rein to your imagination! With the many different options, you can create a personalized rifle with minimal effort. Discover Easy Custom now!





Dare to be different

Give your gun a personal touch with our ten versatile basic colors for high-quality leather and contrast stitching. Also discover our exclusive exotic leather options such as the alligator, cayman, and snake leather from our range. Turn your R8 or K95 leather model into a unique masterpiece with a touch of personality. In addition to the large selection of leather types, the styling of the stock insert offers many options for further personalization. For example: You can style your rifle with an individual signature or footprint. The pistol grip cap offers additional design options. Customize it with your own logo, a family crest, or your initials. A matching color insert can really make the engraving stand out. You can also complete the harmonious overall styling of your R8 with a personalized bolt handle ball. Add the final touch with engraved steel fish scales, the argali logo, color-accent initials, or gold details.

Design your personal hunting rifle with us, exactly as you like.



Discover
Easy Custom now





Technical coatings

The anodized surface offers a number of benefits: It protects against corrosion and increases the resistance against scratches. The matt surface minimizes unwanted light reflections while improving heat dissipation. These coatings therefore offer the ideal combination of aesthetics and functionality. The “Gun Metal Grey” variant is referred to as a “brushed steel gray”. It imitates the look of steel, but is made of high-strength lightweight aluminum. As an alternative, we offer the black housing in “brushed black”, which also offers an elegant look with the lowest possible weight. This variant also uses aluminum as the base material.



Our Easy Custom standard models offer that little something extra – carefully selected by us. Visually coordinated details create a harmonious overall design and give each Easy Custom firearm a unique appearance.

EASY CUSTOM IN SERIES



R8 Ultimate Silverstone
more information on page 26



R8 Ultimate Rose
more information on page 57



R8 Success Vintage
more information on page 52



R8 Ultimate Carbon Diamond Line

TECHNICALLY OPTIMIZED

CustomTec uses unique high-tech innovations to achieve individuality and perfection. Technology taken to the max, for ultimate power and performance.



Fig. shows an R8 with diamond fluting

CustomTec fluting

The CustomTec fluting options offer maximum weight reduction with high stability and better heat dissipation thanks to an even larger surface compared to our standard fluting. Their unique structure also makes them visually appealing.

CustomTec fluting is available in two variants:

Diamond fluting: possible for R8 barrels (17 – 22 mm) up to 520 mm barrel length

Helical fluting: possible for R8 barrels (17 – 22 mm) up to 580 mm barrel length

CUSTOMTEC

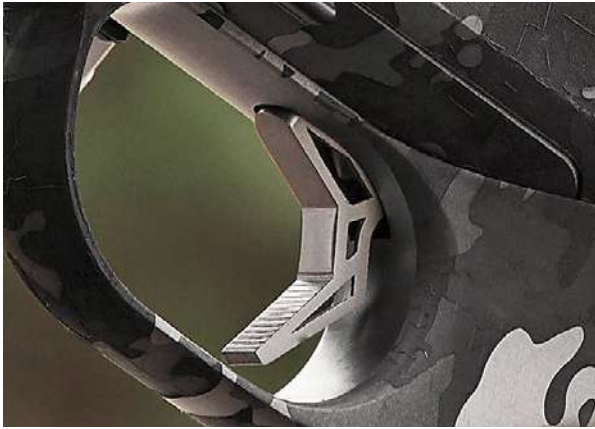

CustomTec trigger

The skeleton CustomTec trigger was designed to provide shooters with the greatest possible repeat accuracy for positioning the trigger finger. The characteristic geometric shape of the trigger guides the shooter's finger to the same point every time, supporting even bending.



CustomTec bolt handle ball

Enhanced design of the match bolt handle ball with ergonomically positioned milled areas for even better grip and reliable repeating.



CustomTec special twist lengths

Our standard twist lengths are based on practical hunting experience and stabilize the typical bullets of the respective caliber. Special applications, such as long-range shooting, often use bullets that require faster twist lengths to reveal their full potential. In order to offer those customers the optimal barrel for their requirements, we provide the option of manufacturing barrels with special twist lengths as part of our CustomTec range.



SILENT HUNTER

CALIBER .300 BLACKOUT



R8 Ultimate Silence Blackout

The silent hunter shares its characteristics with the .300 Blackout – silent, compact, efficient. Black like the night and extremely short, the R8 Ultimate Blackout is a well-balanced overall composition that perfects the unit of rifle and ammunition.

The .300 Blackout caliber is available in supersonic and subsonic versions. Subsonic ammunition with a V0 of below 340 m/s is ideal for situations, such as hunting predatory game, where extremely low sound signature is helpful. The shot sound is almost fully reduced with subsonic loads. Traditional supersonic ammunition enables an extended range of hunting applications including roe deer, still with significantly reduced noise emission. The caliber is ideal for hunting over moderate distances and the use of extremely short barrels.



FIELD & FOREST COLLECTION

ROBUST COMPANIONS FOR HUNTING

It is freezing cold, your breath is swirling like clouds, the silence is shattered by the barking of excited dogs. Beaters and dog handlers make their way through difficult terrain, dry leaves are cracking on the ground. Steep inclines, dense bushes, thorny shrubs. The forest is rustling, the game is in motion. This is exactly where the Field & Forest range is at home: It is designed for tough use when stalking, tracking wounded game, or anytime you are out in the field and forest. Extremely durable, weatherproof and breathable fabrics control the microclimate. Stretch inserts ensure maximum freedom of motion providing the utmost wearability and comfort.

Discover
FIELD & FOREST





left: **Blaze Trucker Cap** High visibility and breathability for forest and field hunting. **Striker DH Vest** Full-featured dog handler vest with high durability and weather protecting fabric. **Fleece Jacket Kylar** Sporty fleece jacket with Suede inserts for an elegant look. **Striker WP Pants** The Striker Pants are the bombproof counter part to the Striker Jacket. The pants are fully equipped with six external pockets to easily store all your hunting necessities as well as ammunition. right: **Striker SL Cap** The Striker SL Cap perfectly rounds off the Striker outfit. **Tackle Softshell Jacket** The Tackle Softshell Jacket combines high durability with full freedom of motion and weather protection. With reinforcements from the knees downwards.



Traveller Hat The Blaser hat made from exquisite Merino virgin wool! Famous for its versatility, proven as headgear in rain or sunshine. **Stealth 2L Jacket** Weatherproof and silent jacket designed for field or forest hunting. Certified according to DIN EN17353:2020 Type A. Increased visibility during the day.

Developed for hunting – with proven fabric technology.

Robust, durable, functional – all fabrics used in the Field & Forest items originally come from the field of workwear or military clothing, where they prove their durability every single day. The basic fabric, OXFORD NYLON 6.6, is particularly robust and provides the durable foundation for the Field & Forest collection. Key areas like knees, buttocks, and the lower sleeves are additionally reinforced with 100% CORDURA®. The result: Hardly any abrasions and wear, with maximum wearing comfort! For optimum freedom of movement, STRETCH CORDURA® is used in the upper sleeve and back areas.

Jacket Janina Maximum comfort for all hunters who spend extended periods outside at low temperatures. Certified to DIN EN 17353:2020 Type A. Increased visibility during the day with color 333 Blaze Orange Camo.

Striker SL Cap The Striker SL Cap perfectly rounds off the Striker outfit. **Striker Jacket** The Striker Jacket brings together bombproof durability with freedom of motion – for maximum comfort, even in rugged terrain.





Striker SL Cap The Striker SL Cap perfectly rounds off the Striker outfit. **Tackle Softshell Jacket** The Tackle Softshell Jacket combines high durability with full freedom of motion and weather protection. **Tackle Softshell Pants** The Tackle Softshell Pants combine high durability with full freedom of motion and weather protection. With reinforcements from the knees downwards.

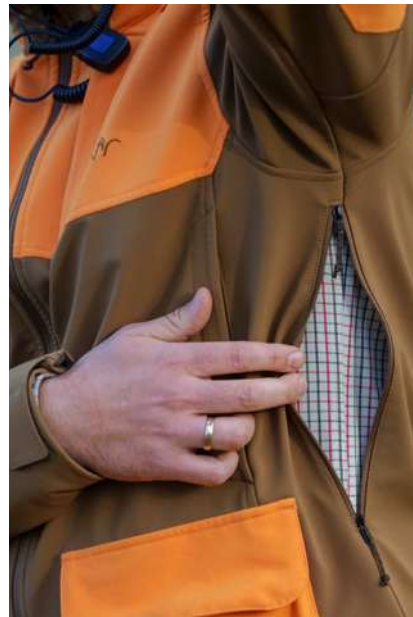



Pearl Beanie Winter beanie with attractive pearl knit design and Argali logo jacquard.
Striker Jacket The Striker Jacket brings together bombproof durability with freedom of motion – for maximum comfort even in rugged terrain. **Striker WP Pants** The Striker Pants are the bombproof counter part to the Striker Jacket. The pants are fully equipped with six external pockets to easily store all your hunting necessities as well as ammunition.

Tackle Softshell Jacket The Tackle Softshell Jacket combines high durability with full freedom of motion and weather protection. **Striker SL Pants** All-around pants for hunting or hunting maintenance work. Designed in close collaboration with professional hunters, they provide a high level of durability for 3 season use.



SOUND OF SILENCE

The construction of the R8 Silence is designed to protect the hearing of both hunter and dog. At any time and with every shot. Thanks to the even weight distribution of the entire barrel, the R8 Silence models with integral silencer provide the first-class balance and huntability that you are used with every R8 model.



Perfect Balance

The weight of the silencer is distributed over the entire length of the barrel, which improves balance and handling, providing perfect target acquisition.

Free Field of View

No obstructed field of view at low magnification for maximum and unrestricted view as it is indispensable for driven hunts. In addition, the R8 Silence offers best conditions for the use of clip-on devices, since there is no danger of collision.

Elegant Aesthetics

The outer contour of the barrel and silencer jacket made of titanium boasts a smooth bull barrel design, giving the R8 Silence models their low weight and an extremely elegant overall appearance.

Well-Protected

The Blaser Integral Silencer offers optimum silencing performance due to its innovative design that utilizes the entire length of the silencer as expansion space. The inner tube reliably protects the barrel against powder residues, contamination and corrosive residues.

Reliably Connected

The extremely lightweight muzzle brake made of titanium provides the reliable connection of muzzle thread and integral silencer. It enables the integral silencer to be mounted with repeat accuracy, ensuring that the point of impact remains unchanged.

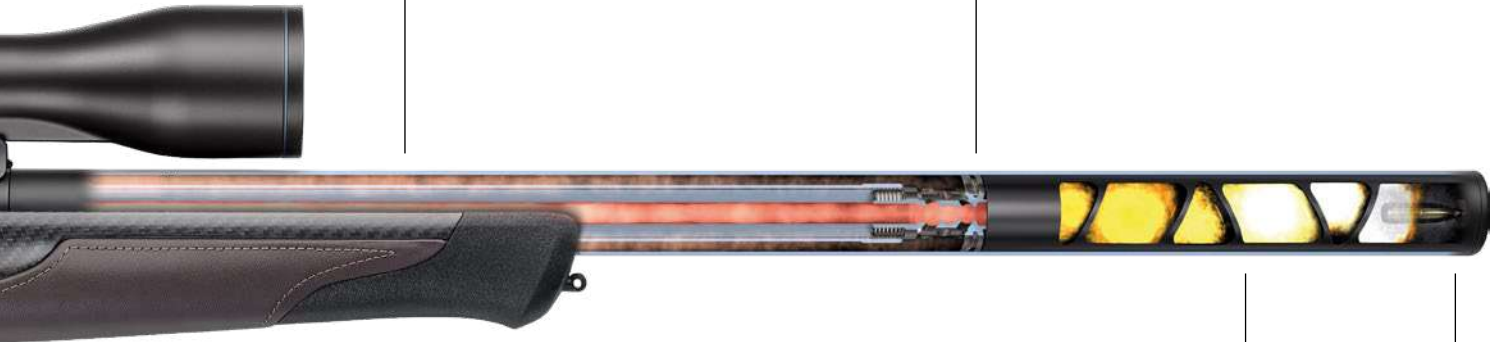

Extremely Silent

Baffle geometry is crucial for recoil reduction and protection of the shooter's hearing. For the Blaser Integral Silencer (ISD), the geometry was optimally adapted to the diameter of the R8 Silence.

Rapidly Damped

Within a fraction of a second all the processes take place inside the silencer to ensure noise dampening and recoil reduction when the shot is fired. As an example, with a barrel length of 42 cm (16.5") in .308 Win. the projectile emerges from the muzzle at a velocity of 750 m/s. It passes completely through the length of the integral silencer in just 0.27 milliseconds.

The Perfect Choice – R8 Silence in 8,5x55

The success story of the R8 Silence is better shooting. Together with the extremely powerful 8,5x55 Blaser caliber, which was specially developed for short barrels, the R8 Silence represents a unique combination that cannot be beaten in terms of huntability and performance. Learn more about the R8 Silence in caliber 8,5x55 Blaser on page 97.

THE *Highlander*

As in many other regions of Europe, red deer are now also being targeted by conservation organizations in Scotland. This species has already been almost wiped out in some areas as part of reforestation measures. Niall Rowantree, one of Scotland's best-known professional hunters, considers such an approach to be misguided for various reasons.







As a hunting consultant and manager of a number of large estates in the north of Scotland, Niall Rowantree sees and feels the consequences of radical hunting on a daily basis. Today, many estates have little tolerance for red deer, and a result of the constant hunting pressure, the animals migrate to neighboring regions, thus increasing the population elsewhere. Niall also never tires of emphasizing the important role that red deer – along with sheep – play in maintaining the largely treeless moors. Not only do very rare plant species thrive on Scotland's moors, but they also store more greenhouse gases than all the forests of the northern European continent combined.

Niall Rowantree's task is to find compromises in close consultation with the landowners and to develop his own hunting strategy. The aim is to strategically reduce the red deer population with and at the same time avoid unnecessary stress for the game. For Niall and other professional hunters, the use of silencers has therefore long been mandatory.

Hunting guests from other countries come into play, especially during the deer rut, in order to at least partially finance these hunting measures that serve nature conservation. This results in a win-win situation for everyone involved.

Reliable equipment, such as the R8 Ultimate Silence combined with a B2 riflescope, which can withstand the harsh Scottish weather conditions is of utmost importance.



“As hunters, we play a regulatory role in maintaining the health of red deer. However, we must never forget that this game species contributes significantly to the conservation of the raised bogs which, as the largest greenhouse gas reservoirs, are indispensable in terms of climate protection.”





“In order to hunt effectively and spare the game unnecessary stress, silencers are obligatory for us. With the R8 Silence, there is now finally a rifle that is silenced and at the same time short and very handy.”

*The perfect combination:
R8 Ultimate Silence and the
Blaser B2 3-18x50 iC QDC*.*

ELEGANCE IN WOOD.



R8

The basic model of the R8 range offering all the benefits of a high-performance hunting rifle.

- Receiver in matt black
- Stock with Bavarian cheek piece and double rabbet
- Rubber recoil pad
- Black fore-end tip
- Grade 3 wood
- Optional barrel design Silence with integral silencer

ic illumination
CONTROL



Discover the Blaser
stock portal now!





R8 Success

The ergonomically perfect Blaser thumbhole stocks provide constant accurate shooting for every situation. With the R8 Success, aficionados of precious stock wood will also benefit from this ingenious stock design. The R8 Success Leather is the first to combine fine walnut wood with premium leather. Thanks to the two-piece thumbhole stock its matt black receiver appears particularly elegant.



- Two-piece, ergonomically perfect walnut wood thumbhole stock
- Ebony fore-end tip
- Cheek piece with stainless steel brace
- Rubber recoil pad
- Receiver in matt black finish with gold-colored R8 lettering
- Grade 4 and 7 wood
- Optional with leather inlays and stock brace
- Optional barrel design Silence with integral silencer



ic illumination
CONTROL



Discover our entire portfolio
on www.blaser.de

R8 Success Vintage

The R8 Success Vintage with a wooden thumbhole stock combines high-quality materials and exclusive finishes to create a unique composition.

- Receiver and trigger guard made of black, matt brushed aluminum
- High-quality inlays made of brown saddle leather on fore-end, pistol grip and comb as well as recoil pad.
- Grade 6 wood with a matt finish
- Wooden bolt handle ball
- Gold-plated trigger
- Gold colored, titanium-nitrated bolt
- Optional barrel design Silence with integral silencer

ic illumination
CONTROL





WE
RECOMMEND
8,5x55
BLASER





R8 VERSIONS

The R8 Luxus versions give every R8 the stylish appearance of a traditional hunting rifle. Roe deer, red deer, wild boar, chamois – a variety of high-quality laser engravings are available. The classic stock in grade 4 wood with a Bavarian cheek piece and double rabbit rounds off the R8 Luxus variants. Each R8 Luxus variant is optionally available as an R8 Success variant with a two-piece, ergonomically perfected wooden thumbhole stock and optional impregnated leather inlays.



Discover our entire portfolio
on www.blaser.de





LADIES' CHOICE



R8 Intuition

With the R8 Intuition Blaser now offers a rifle featuring a purpose built stock that takes into account the anatomy of women. In combination with a slender pistol grip, this optimally designed Monte Carlo stock maximizes comfort and provides ample surface area for a proper cheek weld to the stock allowing the huntress to fully unlock the potential of the R8. The R8 Intuition stock is also optionally available for other models featuring a wooden stock.

- Receiver in matt black finish with gold-colored R8 lettering
- Optimized Monte Carlo stock, overall length 350 mm (13.78")
- Ergonomically optimized pistol grip
- Extra soft Blaser Comfort recoil pad
- Black fore-end tip
- Grade 4 wood (optional 7)
- Stainless steel brace fitted in stock
- Optional barrel design Silence with integral silencer

ELEGANT.
INTUITIVE.



R8 Ultimate Rosé

Maximum performance with a touch of feminine design: The R8 Ultimate Rosé is the rifle for female hunters who prefer understated elegance and confident styling.

- Ultimate stock in black with adjustable comb
- Shortened barrel with muzzle thread
- Bolt handle ball: steel with knurled profile and flower
- Rose-color Argali logo on the receiver
- Anthracite suede leather inlays with rose-color contrast stitching
- Black pistol grip cap with rose-color "Ladies Edition" lettering with arabesque filling
- Compact recoil pad (350 mm)
- High-quality custom rifle sling made of anthracite suede leather with rose-color contrast stitching
- Optional barrel design Silence with integral silencer



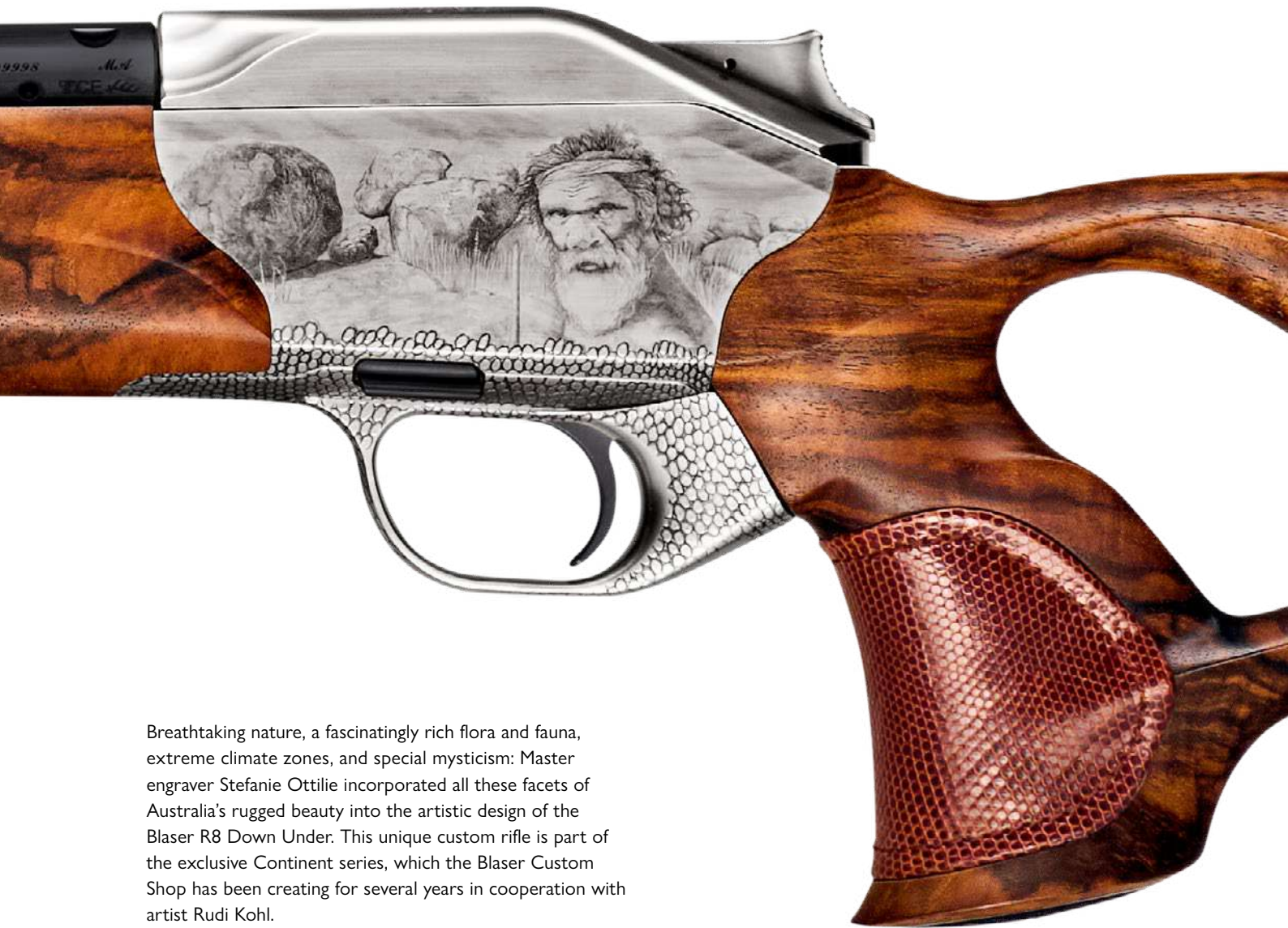

Breathtaking nature, a fascinatingly rich flora and fauna, extreme climate zones, and special mysticism: Master engraver Stefanie Otilie incorporated all these facets of Australia's rugged beauty into the artistic design of the Blaser R8 Down Under. This unique custom rifle is part of the exclusive Continent series, which the Blaser Custom Shop has been creating for several years in cooperation with artist Rudi Kohl.

The housing features an engraved photorealistic portrait, embedded into the scenery of Ayers Rock, while on the other side a sand goanna gazes into the expanse of the Australian savanna. The main design is framed by a lizard skin texture, which is also repeated on the stock insert. A subtle boomerang adorns the trigger, jumping kangaroos can be found on a silver inlay in the stock, and the barrel and bolt handle are embellished with the symbols of sun and snake. The redback spider with its distinctive red mark adorns the pistol grip cap. The bolt handle ball, designed as a globe to reference the Continent theme, completes the masterful engravings on the R8 Down Under.

The final touches on this wonderful composition in caliber .300 Win. Mag. are the ergonomic Blaser R8 Custom Success wooden thumb-hole stock with Super Finish in wood grade 10 and the leather insert made of lizard skin – for a truly unique look and feel.

UNDER THE SIGN OF THE SUN AND THE SNAKE



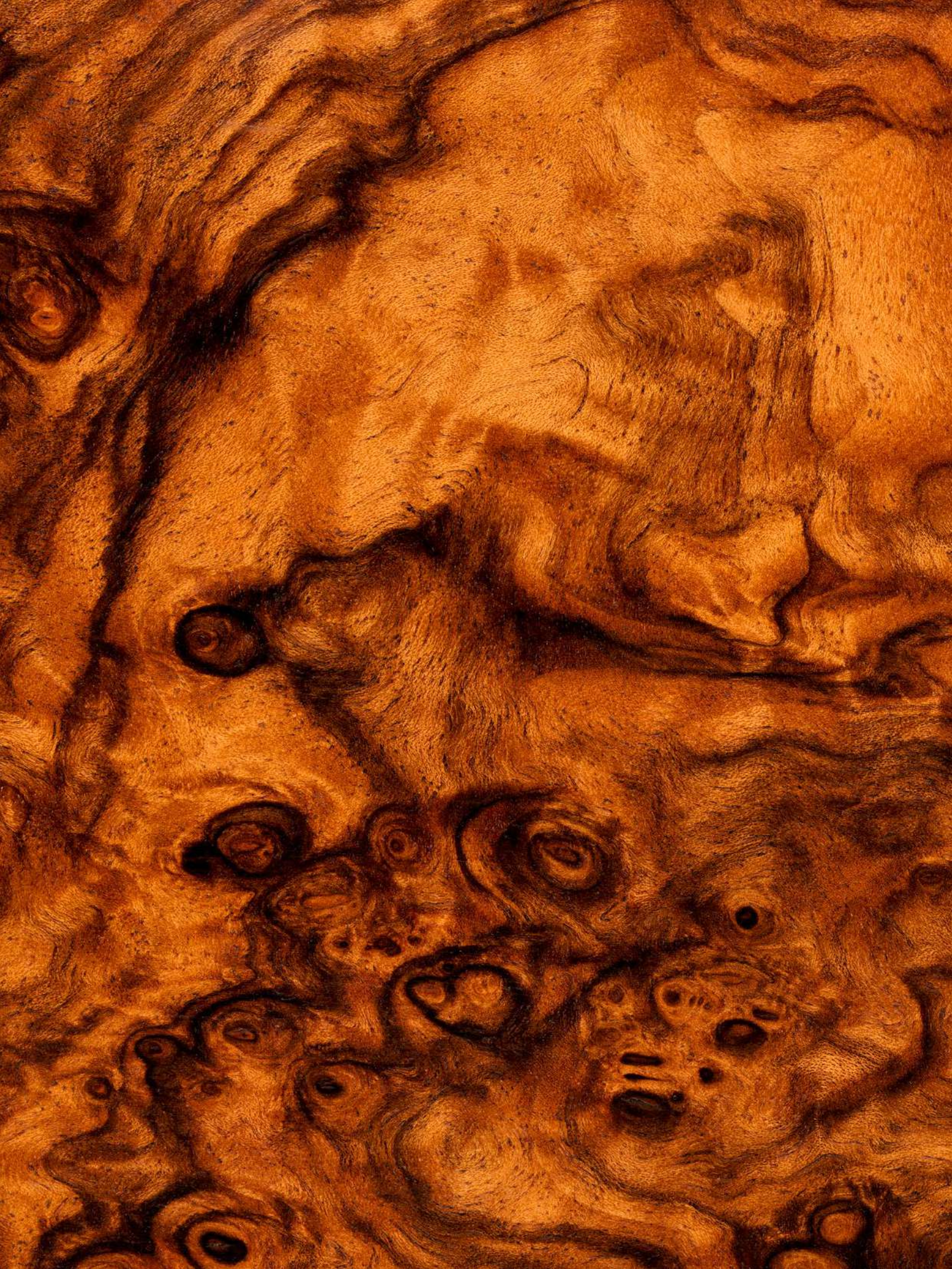

UNIQUE PIECES WITH CHARACTER

Wood is a symbol of life in nature. Why not add some life and personality to your hunting firearm?

Choose your individual stock wood online from our stock portal. You will be guided through the selection process, from choosing the model and configuring the stock to deciding on a stock shape and barrel contour.

Caucasian walnut trees grow slowly on barren ground in rough conditions in Eastern Europe and West Asia, exposed to the whims of nature over many years. The burl wood from these fine trees is prized, especially for its aesthetic and physical properties. The fine but distinct grain gives the wood its unusual, striking character while also making it highly robust. Stocks made from this exquisite wood are available in wood grades 6 to 10. Get a preview of your finished firearm in our stock portal and reserve your unique stock wood with a single click.

As an alternative, you can arrange for a hands-on experience through your Blaser dealer. Select your preferred stock wood in person from a large selection of raw pieces. At our stock selection showroom in Isny, you can run your fingers over the grain and hold the raw pieces in your own hands.

Personally selected by you and turned into pure elegance by our experts, the high-quality stock wood will add a very special character to your Blaser hunting firearm.



Wood grade 6



Wood grade 7



Wood grade 8



Wood grade 9



Wood grade 10



Discover the Blaser
stock portal now

STOCK PORTAL

PEOPLE & PASSION

Bodyguard

In the west of South Africa, near Kruger National Park and Mozambique, Ian Brown found his calling twenty years ago when he started working at family-run Wayne Wagner Safaris. Since then, countless hunters have benefited from his experience and his affinity for nature.



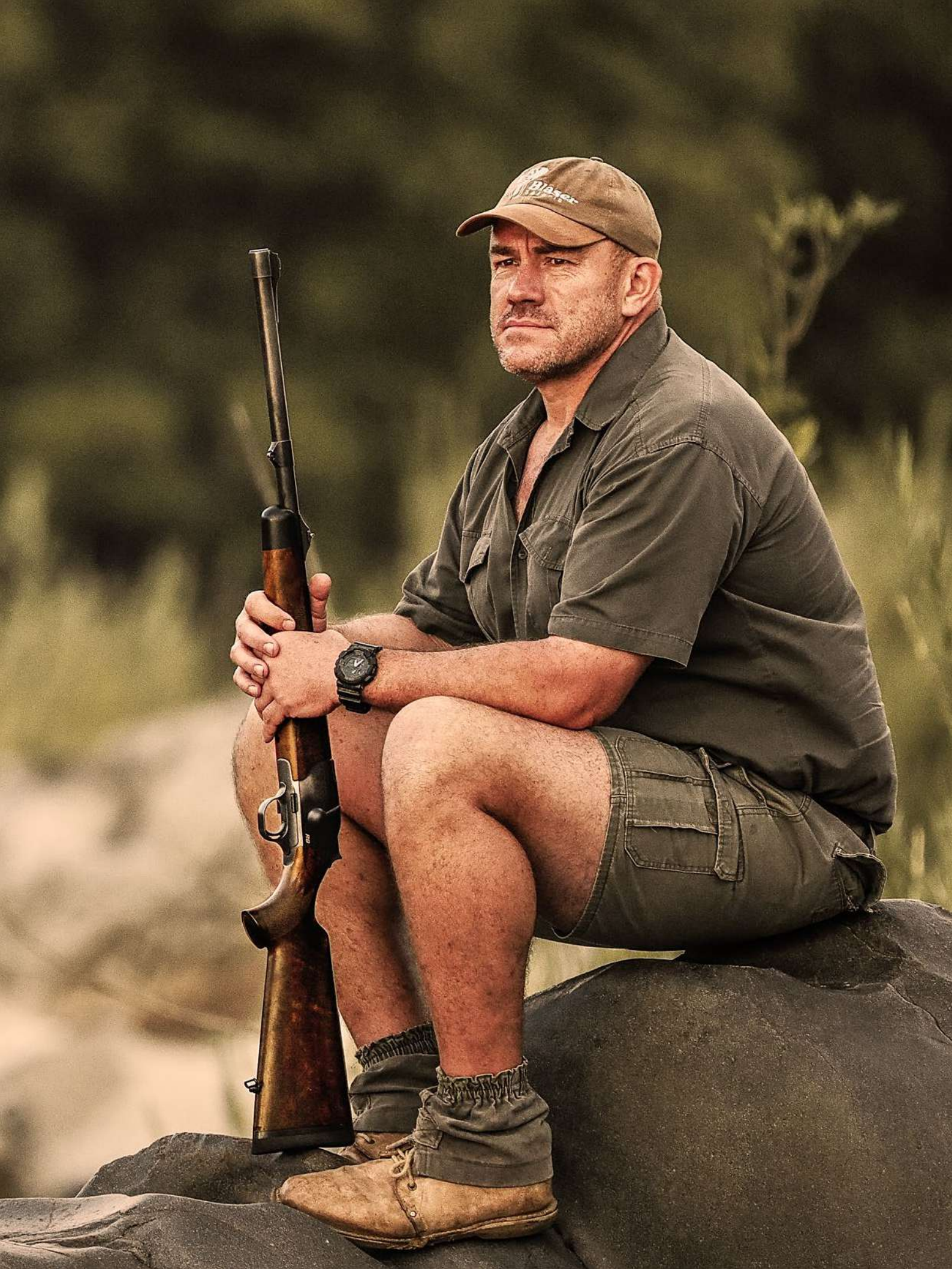



“The R8 enables me to fire three .500 Jeffery caliber shots in a flash. It’s like having a life insurance policy.”

Anyone who heads out into the bush in South Africa or Mozambique with professional hunter Ian Brown can tell he’s an absolute pro within minutes. Every move is perfect. Everything is well planned. There is never even a hint of stress. And while out on the hunt, he teaches his clients an incredible amount about the flora and fauna, without overloading them with information. This makes hunting days and two- or three-day tours through Kruger National Park all the more enjoyable. The game reserve also gives visitors the impression of an untamed Africa, even today. Both because of the wildlife and the seemingly endless expanses of savanna.

This unparalleled feeling of entering untouched habitats can also be experienced in large parts of Mozambique, where Wayne Wagner Safaris organizes and provides guides for buffalo hunts. Ian Brown is in his element here, especially when it comes to giving his guests what they came for. As hunting is anything but predictable, knowing that Ian Brown always has a watchful eye over the situation is a remarkably calming feeling. As is the fact that he knows his way around his R8 in .500 Jeffery caliber... In case the worst were to happen.

“When hunting, you cannot predict every situation. So it’s vital to always be alert and ready to take action in the worst-case scenario.”



R8 Kilombero

High-performance big game rifle with classic looks: the R8 Kilombero features simple elegance and every technical advantage possible to aid a successful African hunting trip.

- Matt black steel receiver
- Safari open sights: express sight, classic ring mount, silver bead
- Sling swivel with ring around the barrel
- Safari stock with larger radius at comb and Monte Carlo cheek piece
- 2.7 cm (1.1") safari rubber recoil pad
- Kickstop
- Safari fore-end with black fore-end tip
- Grade 4 wood
- Compatible with all R8 barrels

ic illumination
CONTROL



R8 Professional Hunter

Thanks to its rugged synthetic stock, the R8 Professional Hunter is designed for the hardest conditions and highest demands.

- Integrated steel receiver
- Safari open sights: express sight, classic ring mount, silver bead
- Sling swivel with ring around the barrel
- Professional recoil pad
- Kickstop
- Professional synthetic stock with black elastomer inlays in savannah, dark green, black and optional camo
- Compatible with all R8 barrels

ic illumination
CONTROL

Hunting in South Africa
See the video







R8 PROFESSIONAL

The R8 Professional is designed for hard use: elastomer inlays support secure grip and aiming even in wet conditions. The specially developed recoil pad combines outstanding recoil reduction with excellent sliding characteristics.

- Synthetic stock with black elastomer grip inlays, available in dark green, savannah or black-brown
- Optional adjustable comb

ic illumination
CONTROL



Stock color savannah



Stock color dark green

R8 Professional Nachsuche

The same as the R8 Professional, but includes:

- short tracking barrel (50 cm / 19.7") and HIVIZ® quick acquisition sights
- retainers for sling swivels on the muzzle as well as on both sides of the stock



Matching tracking rifle sling

Blaser On-Barrel Silencer

The On-Barrel Silencer developed by Blaser is designed to fully meet the requirements and needs of hunters. It is threaded onto the barrel and thanks to the particularly slim design of the silencer, the open sight can be used even with the silencer attached. The Blaser On-Barrel Silencer is one of the lightest on the market and is made of special aluminum alloy in combination with titanium to ensure exceptional durability.



Any R8 and K95 can optionally be factory fitted with the muzzle thread required for the Blaser On-Barrel Silencer. All barrels with a muzzle thread have the front sight set back by approx. 17 mm.

It is also possible to retrofit a muzzle thread with cover.

SILENCER



Blaser Over-Barrel Silencer

The ideal silencer when a short overall length is required. The combination of a special aluminum alloy and steel ensures a low weight and yet a long service life.

It must be noted that the Blaser Over-Barrel Silencer can only be mounted on barrels without open (front) sight. For retrofitting a muzzle thread with cover, the front sight has to be removed.

How to find the right silencer:
To the video



Blaser Ear Protector 2.0 Essential

The latest generation of the Blaser Ear Protector was developed specifically for hunting and its special requirements. The Blaser Ear Protector 2.0 Essential provides non-electronic hearing protection. Thanks to its soft silicone gel pads, these earmuffs can be worn comfortably over extended periods and can be put on and removed on the hide without any sound. The shells are easy to interchange and can be individually adapted. Interchangeable shells in brown, HunTec Camo, and orange included.



EAR PROTECTOR

Blaser Ear Protector 2.0

The electronic Blaser Ear Protector 2.0 combine first-rate hearing protection of 26 dB SNR with top sound quality thanks to Bluetooth 5.1 technology. To ensure maximum versatility and compatibility, the Blaser Ear Protector have Bluetooth capability and an AUX port. The volume can be adjusted intuitively with a wheel. Loud impulse noises, like gunshots, are dampened automatically, while quiet ambient noises like the soft rustling of game in the foliage are amplified. The shells are easy to interchange and can be individually adapted. Interchangeable shells in brown, HunTec Camo, and orange included.





Driven Hunt Slip Bag – striking and functional

This slip bag, made of resistant tarpaulin material, offers plenty of storage space and a clever multi-functional design. It is robust, easy to clean and water-repellent. Several side pockets offer space for accessories. When empty, it can be folded and used as a seat pad. With the integrated carrying straps, the slip bag can be carried like a backpack or attached in the car.



Competition Slip Bag – clever and stylish

The striking complementary colors blue and orange turn the Blaser Competition Shotgun Slip Bag into a real eyecatcher. The zipper in the upper third ensures safe transport (without the gun slipping out) while allowing fast access to the shotgun.



Canvas/Leather line – robust and elegant

Resistant cotton canvas and high-quality cow leather give the slip bags from the Canvas/Leather line their outstanding durability. The fine pull-up leather develops a unique patina over time, turning each slip bag into a one-of-a-kind. Available as a short or long rifle slip bag and as a shotgun slip bag.



Leather line – durable and full of character

Quality, style, and functionality – the slip bags from the Leather line are made of the finest pull-up leather. This material makes them not only particularly durable, but also gives them a unique aesthetic. The high-quality leather outer fully encloses the main compartment of the slip bag, while the soft sherpa material on the inside securely envelops the gun. Available as a rifle or shotgun slip bag.

SLIP BAGS



Silence Slip Bag – compact and comfortable



Designed specifically for the Blaser Silence rifles, this slip bag impresses with its compact overall length. The outer side pocket offers additional storage space for the removed integrated silencer. The robust high-quality materials, clever compartments, and the compact design make the Silence Slip Bag a handy organizer for hunting.



Essential line – durable and stylish

These slip bags, made of durable and robust polyester, offer reliable protection in any situation. The embroidered Argali logo on the front and the shoulder pad of the carrying strap complete the stylish look of the Blaser Essential Slip Bags. Available in short, long, as a dual slip bag, or as a shotgun slip bag.

ELEGANT. HUNTABLE. ACCURATE. K95

-  K95 barrel profile standard, round
-  K95 barrel profile, octagonal
-  Fluting



6,5 PRC: Caliber range expanded with this high-speed caliber that delivers high intrinsic precision and moderate recoil characteristics. Particularly suitable for hunting at long distances. Find the complete caliber overview at www.blaser.de.

K95 SUCCESS LEATHER

Exceptional elegance meets refined ergonomics! Consistently good aim with a relaxed posture of shooting hand and arm: The benefits of the ergonomically perfect Blaser Success thumbhole stock are now available for the K95. The K95 Success Leather model additionally impresses with the visual and tactile qualities of the leather grip inserts. Other features:

- Two-part, ergonomically perfect walnut wood thumbhole stock
- Ebony forearm tip
- Stainless steel plate in the butt stock
- Rubber recoil pad as standard
- Receiver in matt black finish with gold-colored K95 lettering
- Available from wood grade 4
- Optional left-hand stock

ic illumination
CONTROL

The K95 single-shot rifle has proven itself in demanding hunting situations for decades and still embodies hunting in its most stylish form. Its elegant and compact design are a particular pleasure to use in any hunting situation.



*The ergonomic thumbhole stock

The Blaser Success stock has an ergonomically perfect design and helps the shooter achieve a better mount as it ensures the completely relaxed posture of the shooting hand and arm – whether lying down, free-handed, or supported. This increases the accuracy of the shooter while the specially developed, adjustable recoil pad substantially reduces recoil.





ONE
SHOT.
ONE
HIT.



K95

Proven successful for decades, enhanced and optimized over time – the Blaser K95 single shot rifle. The straight, slightly raised comb ensures comfortable shooting and emphasizes the timeless appearance of this elegant rifle. Animals, ornaments, or arabesques – the Blaser K95 with a classic wood stock is also available in a Luxury version with engraving.

- Receiver in matt black finish with gold-colored K95 lettering
- Ebony forearm tip
- Rubber recoil pad as standard
- Grade 3 wood
- Optional left-hand stock
- Optionally available in the Luxury version

ic illumination
CONTROL



K95 Stutzen

The handy Blaser K95 single shot rifle as a compact Stutzen version with a split forearm and a black forearm tip – predestined for stalking, the mountains, or narrow hunting blinds.

- Black forearm tip
- Barrel length of 50cm (20")
- Optionally available in the Luxury version (see image)

ic illumination
CONTROL



K95 Black Edition

Purist design in its most beautiful form. As a special model with a classic stock, the K95 Black Edition features a black anodized receiver with long side plates and a wood-grade 6 stock. A single shot rifle for style-conscious hunters who prefer an understated look.

- Long black side plates
- Forearm tip made from ebony
- Rubber recoil pad as standard
- Optional left-hand stock

ic illumination
CONTROL



Discover our entire portfolio
on www.blaser.de



K95 Ultimate

Robust design and legendary shooting accuracy. Thanks to its ergonomically optimized synthetic thumbhole stock, the K95 Ultimate combines tradition and functionality in a unique way.

- Ergonomically optimized synthetic thumbhole stock
- Black-brown synthetic stock with black elastomer inlays
- Receiver in matt black finish with gold-colored K95 lettering
- Prepared for an adjustable comb, adjustable recoil pad, compact recoil pad, or recoil absorption system
- Optionally available as K95 Ultimate Leather with handsome leather inserts on forearm, pistol grip, and comb
- Optional left-hand stock



Create your individual K95!

STOCK OPTIONS

With the modular optional features, you can adapt all K95 models exactly to your individual requirements.

Each K95 Ultimate is prepared for the following extras:

A | Adjustable Comb

Multi-stage comb height adjustment with memory function.

B | Recoil Absorption System

Adjustable recoil pad element with recoil absorption system for comfortable shooting, even with large calibers.

C | Adjustable Recoil Pad 358–392 mm

Recoil pad can be adjusted in length, height, and angle.

D | Compact Recoil Pad

The Compact recoil pad reduces the length of the Ultimate stock to only 350 mm.





K95 Ultimate Carbon NX

Elegant carbon fiber meets matt black finish: The new edition of the K95 Ultimate Carbon features the proven Ultimate stock with a matt surface finish and completes the model with robust elastomer grip inserts. What remains unchanged is our quality promise – the carbon fiber stock is hand-made in Germany. Prepared for an adjustable comb, adjustable recoil pad, Compact recoil pad, or recoil absorption system.

- Carbon thumbhole stock with matt finish
- Receiver in matt black finish with gold-colored K95 lettering
- Rubber recoil pad as standard

ic illumination
CONTROL





TWO *Brothers*
ONE *Passion*

The small town of Los Yébenes, south of Toledo, is considered the center of taxidermy in Spain and far beyond. Today, one workshop in particular stands out: Garoz & Garoz.

This third-generation family business, run by the brothers Juanjo and Ramon Garoz is known by hunters around the world for its artistic skills and refinement.



“My philosophy is to hit the target with a single shot. The K95 makes this really easy for me.”

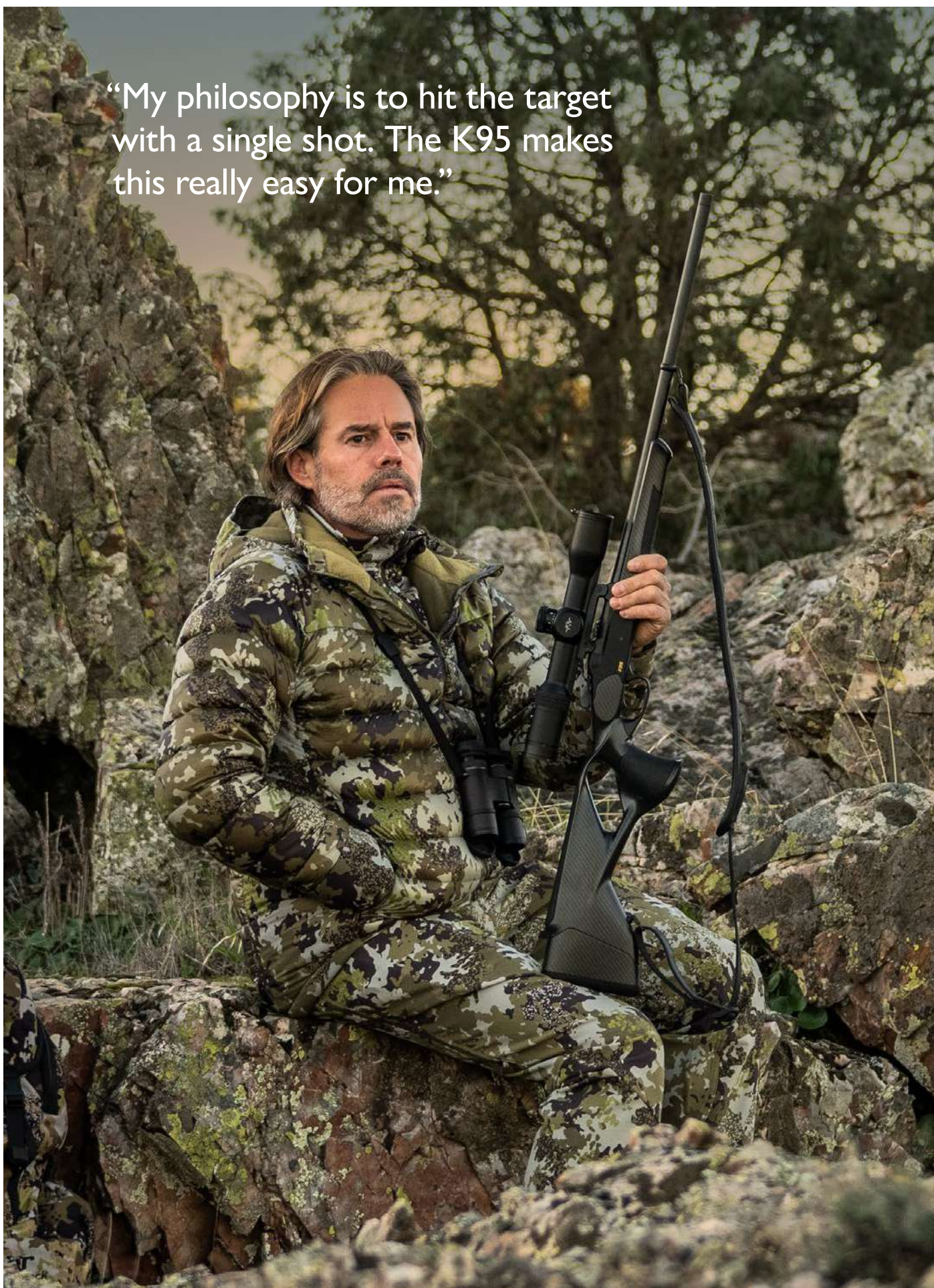

“Taxidermy immortalizes the unique moment. It attests to the respect for game and is intended to remind the observer how important it is to preserve nature and biodiversity.”

Like their grandfather and father, they are both passionate outdoorsmen who have hunted in numerous countries around the world. This experience has not only raised their awareness of sustainable hunting, but also their respect for wild animals. Juanjo and Ramon's motivation for hunting is the experience of unspoiled nature, the pleasure of unforgettable sights and, of course, the passion to bag mature trophies. They do this with great care and intuition and always with the proviso that they never endanger game populations.

For both brothers, immortalizing hunted game in the form of first-class taxidermy means both respecting the animal and preserving special memories. In their own hunting museum, which is known throughout Spain and far beyond, countless taxidermy specimens from all over the world are on display that are hard to find anywhere else in terms of artistic design and variety. In this extensive museum, which is visited not only by hunters but also by others interested in nature, one can immediately sense the amount of care and attention to detail that has gone into its design.

Juanjo and Ramon Garoz's hunting philosophy is also reflected in their choice of equipment. In Ramon's case, it is often the camera with which he is able to capture exciting scenarios in the great outdoors. Juanjo, on the other hand, wouldn't want to do without his K95 rifle. His absolute ambition is to always achieve hunting success with a single, precise shot.



HUNTEC

COLLECTION





RELIABLE COMPANIONS FOR EXTREME CONDITIONS

Your passion is hunting in mountainous terrain. You want to face this challenge in every weather situation. Exhausting, sweaty ascents in severe weather conditions, towards the tree line. Climbing through rubble fields, observing and chasing game through mountain pastures, using every rock and bush to hide. Coming closer by crawling through moistness and dirt. Whenever you have to rely on your gear – you only can rely on the best.

Experience the
world of HunTec!



WHY HUNTEC?

Precision Thermo Regulation (PTR-SYSTEM)

PTR is an insulation system that provides a precise balance of heat retention vs. breathability for all stages of the hunt and for all conditions.

Advanced materials, finishings and insulation technologies are combined to perfectly balance heat retention and breathability for different warmth preferences.

Engineered Freedom of Motion

- Garment seam construction is designed around the hunter's motion radius.
- Integration of 4-way and 2-way stretch fabrics.
- Stretch layering is done from the inside out. For example in the insulation jackets the stretch direction is matched on the lining, insulation and shell fabric.

Lightweight

Materials were selected based on the best possible ratios in terms of

- Weight to Durability
- Weight to Stretchability
- Weight to Quietness
- Weight to Packability

The HunTec line is designed for hunters who want to move fast through challenging terrain with a minimal amount of weight.

HunTec Camo – Our Camouflage Gear

To guarantee the best performance when high demands are placed on your gear while hunting in alpine terrain – this was our goal when developing the revolutionary Blaser HunTec collection. Countless information was processed, tests performed under numerous light and weather conditions in various terrains to ensure a camo clothing line that will live up to its name. HunTec – designed for hunters by hunters and made by Blaser.

Shield Down Jacket Built for extreme conditions. The Shield is our warmest packable down hunting parka. With a 100% waterproof and windproof shell fabric.

Multi-Tube Multi-tube for flexible use either as headwear or neckwear.

Winter Gloves All-around winter gloves for cold weather. Provides full freedom of motion through non-slip leather and preshaped fingers.







Shield Down Jacket Built for extreme conditions. The Shield is our warmest packable down hunting parka. With a 100% waterproof and windproof shell fabric.
Charger Pants Three season hybrid pants for all conditions and all situations.



Challenger Airflake Jacket Lightweight, low pack volume, fast drying, insulated jacket. Full warmth for minimal weight. **Resolution Pants** Maximum freedom of motion. Total weather resistance. The best all-around hunting pants.

Drain Beanie Perfect beanie for high activity on those cold winter hunts or to stay warm while scouting.

Supervisor Jacket The perfect balance between warmth and breathability. The all-round insulation jacket.

Challenger Airflake Jacket Lightweight, low pack volume, fast drying, insulated jacket. Full warmth for minimal weight. **Charger Pants** Three season hybrid pants for all conditions and all situations.





CDC – Controlled Deformation Copper

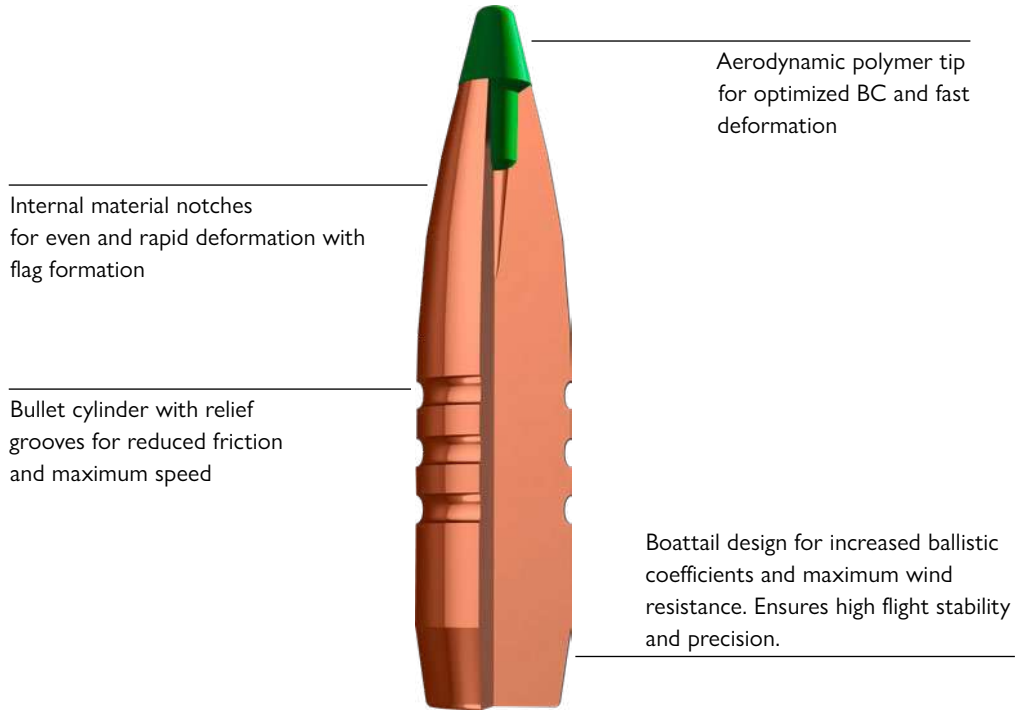

Lead-free to Success

The proven Blaser CDC projectile is designed to deliver a safe and accurate kill, with minimal damage to the game meat. The pure copper deformation bullet mushrooms upon impact on the game body splinter-free and symmetrical in four even petals.

Its deformation is optimized for European game and is initiated quickly by the deep cavity as well as the polymer tip. This results in a very safe killing effect with superior penetration and a high probability of an exit wound. Thanks to its streamlined bullet shape and the aerodynamic polymer tip, the CDC provides good external ballistics and a flat trajectory for long-distance performance.



Special Features at a Glance

- maximum penetration and best protection of venison
- 100% lead-free bullet without fragments
- high speed and extended trajectory



CAUTION: Fire or blast hazard and hazard of fragment projection. Keep away from hot surfaces, sparks, open flames and other sources of ignition. No smoking.

CDB – Controlled Deformation Bonded



Best Effects with Lead

With the further development of the proven Blaser CDP ammunition in terms of its construction, effectiveness, and precision, the new Blaser CDB offers a significantly increased range of applications. The versatile bullet is ideal for all game weights and distances, making it an indispensable tool for every hunter.

The Blaser CDB is characterized by exceptional stopping power and a flatter trajectory, which enables precise and effective shots, even at long distances. With its innovative design, featuring a bullet jacket tapered towards the front and a bullet core that is bonded to the bullet jacket, the Blaser CDB offers superior penetration, and produces a safe kill, with minimal damage to the meat.



Special Features at a Glance

- high stopping power and extended trajectory
- superior penetration and minimum meat damage
- best suitability for all game weights and distances

BLASER AMMUNITION IS NOT OFFERED FOR SALE, SOLD, OR DISTRIBUTED IN NORTH AMERICA.





MAGNUM

The High-performance Caliber for Long-range Shots

In cooperation with Norma, Blaser has developed a brand-new and completely original generation of high-performance cartridges. The latest ammunition technology was applied to achieve optimum performance in each caliber group.

High Accuracy with Good Shooting Characteristics

High precision values in conjunction with notably increased energy and velocity make the Blaser Magnum calibers your best choice for long-range shooting – whether you are hunting in the mountains, in the savanna or on a plateau. Thanks to an optimized cartridge geometry, a stable cartridge base and modern powder types as well as the four-groove barrel profiles and adapted twist rates, the Blaser Magnum offers a more comfortable recoil than other Magnum cartridges.

Four Calibers, Eight Loads

The Blaser Magnum calibers are available with Hornady Interlock, Nosler AccuBond®, Barnes TSX/TTSX and Blaser CDP bullets. Norma also offers additional loads under its own company label.



The range of Blaser Magnum cartridges from left to right:
7mm Magnum with Hornady Interlock bullet; .300 Magnum with TTSX bullet;
.300 Magnum with CDP bullet; .338 Magnum with Nosler AccuBond bullet; .338
Magnum with Barnes TTSX bullet; .375 Magnum with Barnes TSX bullet



CAUTION: Fire or blast hazard and hazard of fragment projection. Keep away from hot surfaces, sparks, open flames and other sources of ignition. No smoking.

STRONG PERFORMANCE. FOR SHORT BARRELS.

The special features at a glance

- powerful magnum cartridge with flat trajectory
- perfect for short barrels with silencer
- modern cartridge geometry and moderate recoil

8,5x55 Blaser

Minimum length. Maximum effect. Magnum character. The 8,5x55 Blaser caliber is made for short barrels and use with silencers. The modern cartridge delivers the highest performance even with barrel lengths of less than 50cm. This makes the 8,5x55 Blaser caliber the all-rounder for almost all kinds of European hoofed game and every hunting situation.



CAUTION: Fire or blast hazard and hazard of fragment projection.
Keep away from hot surfaces, sparks, open flames and other sources of ignition. No smoking.

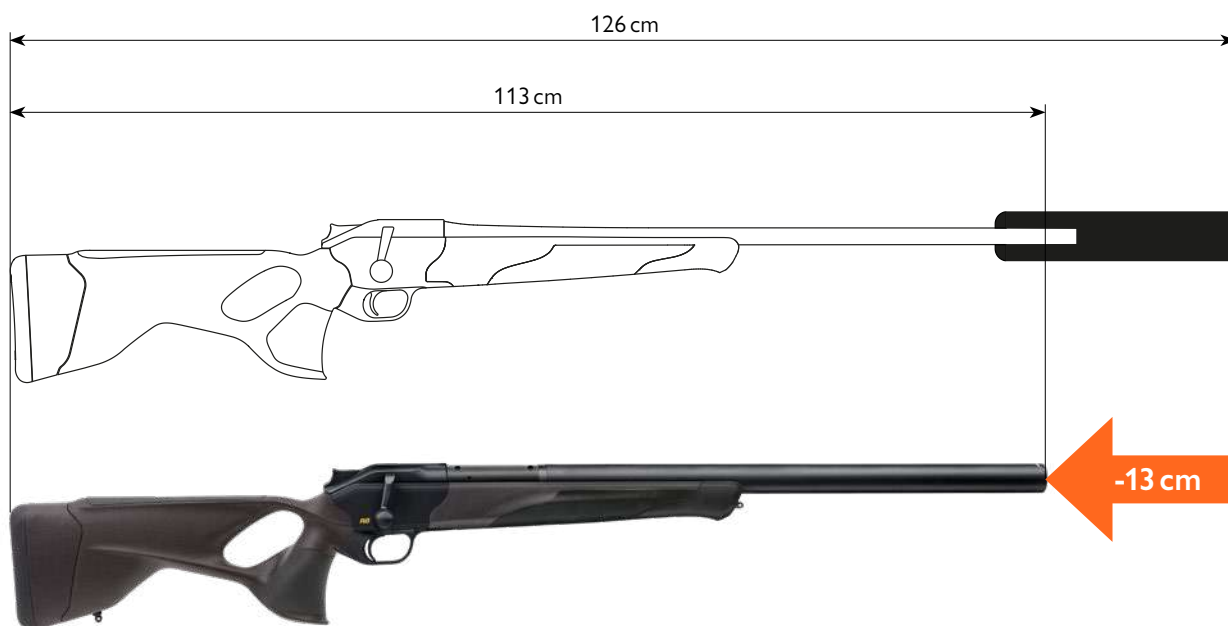

R8 Ultimate in caliber .300 Win. Mag., barrel length 65 cm, Over-Barrel Silencer vs. **R8 Ultimate Silence in caliber 8,5x55 Blaser**, barrel length 47 cm, Integral Silencer

THE PERFECT CHOICE.

R8 Silence in 8,5x55 Blaser.

When it comes to compact overall length with total performance, the bolt action R8 bolt-action rifle is predestined for use with a silencer: The magazine is positioned directly above the trigger and gives the R8 a decisive edge in pointability – already from the start it is shorter than any other conventional bolt action rifle. In combination with a short barrel and the Blaser integral or over barrel silencer this results in a rifle that is hard to beat in terms of huntability.

This is exactly what the 8,5x55 Blaser caliber was developed for. Even with barrel lengths of less than 50 cm, it reaches ideal ballistic values that are normally only achievable with use of longer barrels for high performance calibers.



COMBINATION GUNS

Hunting is as varied as the different hunting grounds you go to. Whether you use a large or small caliber, each rifle has its own specific area of application. The same goes for shot – in many cases shooting with shot is the only option due to safety reasons when hunting down game. It is therefore essential to be prepared for any situation.

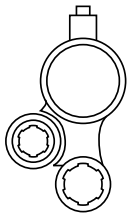

Bockdrilling BD 14

As hunters, we learn to expect the unexpected, whether in a blind or stalking, so it's understandable that we dream of a firearm that will allow us to take advantage of any situation. With the Bockdrilling BD 14, Blaser has developed the perfect blind and stalking firearm – compromises are finally a thing of the past.

The BD 14 has a double-lock system so that a second shot can be taken without having to recock the firearm. Thanks to the free-floating barrels, the point of impact remains constant even with a quick succession of shots, no matter which barrel was fired first. The extremely strong vertical block lock on the BD 14 helps contribute to the high degree of precision.

- Steel-grey anodized receiver, optional black anodizing
- Stock with Bavarian cheek piece
- Rubber recoil pad
- Black fore-end tip
- Grade 3 wood
- Barrels can be adjusted to each other
- Optional in Luxus and Baronesse version
- Optional left-hand stock



Drilling D99

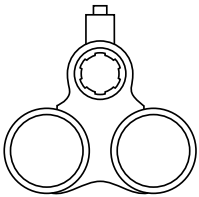

The Drilling D99, with its two shotgun barrels and a rifle barrel, is the best all-rounder. It is the ideal firearm for hunting in areas with small and big game animals. The D99 has a double-lock system so that a second shot can be taken with no hesitation and without recocking.

Thanks to the free-floating barrels, the point of impact remains constant even with quick follow-up shots. The extremely strong vertical block lock on the D99 helps contribute to its exceptional accuracy.

- Edge point engraving with small arabesques
- Black fore-end tip
- Optional with half-beaver tail fore-end
- Stock with Bavarian cheek piece
- Grade 3 wood
- Optional in Luxus version
- Optional left-hand stock





O&U Shotgun Rifle BBF 95/BBF 97



Shotgun and rifle – the classic at Blaser. The barrels can be adjusted to each other by a qualified gunsmith. This means that the Blaser BBF is unbeatable for shotgun slugs.

- Receiver with grained side plates
- Grade 3 wood
- Blaser precision triggers
- Barrels float freely
- Stock with Bavarian cheek piece
- Optional in Luxus and Prestige version
- Optional left-hand stock

Combination guns from the 95 model series are fitted with a single-lock and combined guns from the 97 model series with double-locks. This means that there are two strikers and two firing pin springs in the system. Both systems have their benefits.



Bergstutzen BS 95/BS 97



Many hunters, particularly those with mixed small game and in mountainous hunting areas, want to be able to carry a single firearm with two different calibers. The upper, smaller barrel of the BS 95 or BS 97 lies in a carrier tube and can be adjusted precisely to the bottom barrel.

- Receiver with grained side plates
- Grade 3 wood
- Blaser precision triggers
- Barrels float freely
- Stock with Bavarian cheek piece
- Optional left-hand stock
- Optional in Luxus and Baronesse version
- Also available as double rifle BB 97



Discover our entire portfolio on www.blaser.de



**PROPERLY CONNECTED.
GUARANTEED.
THE ORIGINAL BLASER SADDLE MOUNT.**

**100% RETURN TO ZERO.
RELIABLE.
ACCURATE.**

Blaser's original Saddle Mount has revolutionized the connection between the rifle and the scope. Its consistent accuracy, reliability and precision are legendary and unmatched. Only the original Blaser saddle mount gives you a 10-year guarantee on the shooting performance of our firearms.



Every Blaser rifle or combination gun can be fitted with an original Blaser Saddle Mount. After being zeroed in once, the riflescope can be removed and replaced in just three steps, with no need for tools, as often as desired, with 100% return to zero. This allows you the flexibility to use different scopes on the same barrel.

Four inconspicuous notches on the chamber end of the barrel secure the one-piece mount without tension. The barrel itself is totally free floating. No further work is required on the firearm, and there is no need for large mount bases that can interfere with your sight picture or the look of the rifle. The Blaser saddle mount is available in rail, ring or Picatinny mount versions. Please find further information on our website.





HUNTING AND OPTICS INSEPARABLY LINKED

Blaser is synonymous with hunting like no other company. It is our passion and our drive to develop the best solutions, from hunters for hunters. Because we know: Only the perfect combination of rifle and riflescope provides the best result – the perfect shot in any conditions.

From the Deepest Conviction – with Excellent Expertise

Constant use out in nature and the different aspects of hunting put quite a strain on optics. Our decades of experience, state-of-the-art production methods and innovative technologies – in conjunction with the expertise of some of the world's best optics engineers and specialists – allow us to create sophisticated, high-end products at our factory in Wetzlar, Germany. Thanks to high-quality special lenses, latest lens coatings and the extremely robust construction, which is designed for the use with clip-on devices, our riflescopes offer top performance in every respect. Every Blaser riflescope or pair of binoculars is “Made in Germany” – our promise to you to provide you with fast and uncomplicated support when it comes to service.

OPTICS

THE FEATURES OF OUR RIFLESCOPES

Optical quality, robust mechanical parts, and optimized ease of view make our riflescopes top-quality products in the premium segment. Discover a number of clever practical features for hunting as well as optional accessories for our B1 and B2 riflescope lines.



QDC⁺: PRECISION SHOTS OVER LONG DISTANCES

Technically well equipped for long distances – with the Quick Distance Control⁺ (QDC⁺) that can even be retrofitted.

With the QDC⁺, the shooting distance can be adjusted to up to 500 m directly on the reticle adjustment. For optimum adaptation, the set includes ten interchangeable engraved rings designed for a wide range of hunting ammunition. An additional blank ring is provided for individual markings.

The Blaser QDC⁺ is available in the following versions:

- As standard for the Blaser riflescope B2 3-18x50 iC QDC⁺
- Optionally for all Blaser riflescopes B1 and B2 (except for driven-hunt riflescopes B1 1-7x28 iC and B2 1-6x24 iC S) as a retrofit add-on

Test now!
Blaser ballistics calculator





ILLUMINATION CONTROL: INTELLIGENT ILLUMINATION

The illumination control (iC) controls the automatic activation and deactivation of the illuminated dot. In combination with a Blaser R8 or K95 rifle, the iC is activated and deactivated with the position of the cocking slide. For other hunting rifles, the illuminated dot can be conveniently activated through the ocular flip cover with iC function.

The intensity of the illuminated dot at the time of activation always corresponds to the strength that was last set on the adjustment wheel on the right side of the riflescope.



To ensure the longest possible battery life, the illuminated dot switches off automatically as soon as the rifle is moved to a very steep, vertical or sideways position. The illuminated dot is reactivated automatically when the rifle is mounted. When the lock is released, the illumination is also deactivated completely.

iC illumination
CONTROL

FLIP COVER: CLEVER PROTECTION

Protected against dust, dirt, and moisture: Suitable flip covers for ocular and objective lens are available for each of our riflescopes. These also offer clever additional features: The ocular flip cover with iC function enables intelligent activation of the illuminated dot.



iC Ocular Flip Cover

The iC ocular flip cover is available for all B1 and B2 riflescopes. It protects the lens while supporting the illumination control – for fast and automatic activation of the illuminated dot.

A magnet integrated into the flip cover activates the illumination when the cover is flipped open and deactivates it upon closing. Mounting is as simple as can be: push on and clamp! The dioptic adjustment can still be used as usual.

iC illumination
CONTROL

Objective Lens Flip Cover

Flip covers for protecting the objective lens are available in different sizes to suit any Blaser riflescope. Particularly clever: If a Blaser CM clip-on mount is used, it can be attached without removing the flip cover. This applies to all models except for the Blaser driven-hunt riflescopes.



ATTACHMENT MOUNTS: THE PERFECT CONNECTION OF CLIP-ON OPTICS AND RIFLESCOPE

When hunting at night, having a connection between the riflescope and thermal imaging clip-on device, with high repeat accuracy is crucial for achieving a consistent point of impact. With the Blaser CM and BL adapters, we offer different, perfectly coordinated solutions.



CM Attachment Mounts

The Blaser CM adapters ensure that the riflescope and clip-on device merge into a unit with absolute repeat accuracy in just a few simple steps. The groove allows the attachment mount to be easily slipped over the open objective lens flip cover, offering 100 % protection against rotation. A clamping lever on the side locks everything in place.

**EASY. FAST.
100% RETURN
TO ZERO.**

Available in the variants CM 48, 56, 62, and 64,5; compatible with the Blaser riflescopes B1 2.8-20x50 iC, B1 4-20x58 iC and B2 1.8-10x42 iC, B2 2-12x50 iC, and B2 2-15x56 iC.





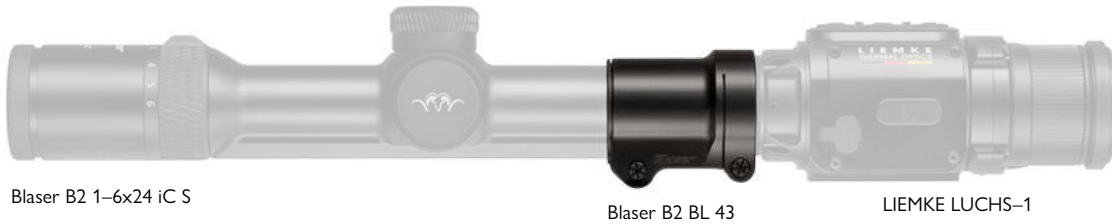

Blaser B2 1–6x24 iC S

Blaser B2 BL 43

LIEMKE LUCHS-1

SUPREME COMPACT AND PRECISE

BL ATTACHMENT MOUNTS

The Blaser BL adapters are perfectly coordinated with the Blaser driven-hunt riflescopes which have a low base magnification and an inner rail that extends all the way to the objective. This makes them ideal for hunting wild boar and for using thermal imaging clip-on devices.

Thanks to automatic positioning and alignment of the attachment mount, the inner rail makes accurate repeat mounting easy and accurate, even in darkness. The attached device is reliably protected against rotation during mounting. A special locking mechanism prevents it from being pulled off to the front and the locking lever always engages in exactly the same position.

Available in thread sizes BL 30, 43, and 52 for mounting different clip-on devices, for B1 1-7x28 iC and B2 1-6x24 iC S in each case.

Overview attachment mounts and add-ons

	B1 1–7x28 iC	B1 2.8–20x50 iC	B1 4–20x58 iC	B2 1–6x24 iC	B2 1.7–10x42 iC	B2 2–12x50 iC	B2 2.5–15x56 iC	B2 3–18x50 iC QDC+
B1 BL 30	•							
B2 BL 30				•				
B1 BL 43	•							
B2 BL 43				•				
B1 BL 52	•							
B2 BL 52				•				
B2 CM 48					•			
B1/B2 CM 56		•				•		•
B1 CM 64,5			•					
B1 Flip Cover iC Ocular	•	•	•					
B2 Flip Cover iC Ocular				•	•	•	•	•
B2 Flip Cover 30 mm				•				
B1 Flip Cover 34 mm	•							
B2 Flip Cover 48 mm					•			
B1/B2 Flip Cover 56 mm		•				•		•
B2 Flip Cover 62 mm						•		
B1 Flip Cover 64,5 mm			•					

For Day and Night

Delicate fiber-optics reticle
with illuminated dot

ic illumination
CONTROL

Ocular Flip Cover

with optional iC function

ic illumination
CONTROL

Consistent Point of Impact

with each change of
magnification

QDC+

reliable shots over long
distances



Precise Adjustment Mechanism

robust metal components and
grippy rubber coating

Made in Germany 

Developed and manufactured
in Germany

For Every Type of Mount

optionally available with inner rail
or 30mm main tube

Objective Lens Flip Cover

optionally with mount for clip-on device

Attachment Mounts

optimized for repeated accurate mounting
of clip-on devices



BLASER RIFLESCOPES – THE BEST FOR SUPERIOR PERFORMANCE

PRECISION TO PERFECTION

Maximum shooting precision in all conditions requires technical solutions that exclude precision-reducing factors – for the rifle, the mount and the riflescope itself. With the Blaser B1 line the reticle is positioned in the first focal plane, due to this special design the point of impact cannot be changed when switching magnification.

Aim Far. Shoot Reliably.

The Blaser riflescopes B1 2.8–20x50iC and B1 4–20x58iC come with Quick Distance Control (QDC) as a standard feature. This feature allows easy height correction of the reticle adjustment, even with the rifle mounted.

Keeping the Perspective

With innovative technology, the Blaser B1 riflescopes offer a clear and narrow reticle in the first focal plane, even at high magnifications. This feature, in conjunction with the adjustable illuminated dot, enables precise shots in all light conditions.

Automatic Compensation and Locking

Parallax compensation comes as standard with all Blaser B1 riflescopes. The adjustment ring at the side automatically locks at 100 m, preventing inadvertent adjustments. For greater distances, the ring can be pulled out and set to the desired distance.



UNCOMPROMISINGLY PRECISE.
SUPERBLY BEAUTIFUL.

B1





B1 1-7x28 iC

Everything in View

Briefly explained



The Blaser 1-7x28 iC offers true initial 1x magnification, allowing the shooter to have the entire shooting field in view with both eyes open. The Intelligent Variable Dot* (IVD) enables fast target acquisition. The generous eye relief of 90 mm reduces the risk of injury, especially with large-caliber rifles. Other advantages include a large field of view of over 40 m, an exit pupil of 10 mm for quick target acquisition, a large magnification range, and an inner rail for precise mounting.

*Intuitive Target Acquisition Thanks to Automatic Illuminated Dot

In the magnification range from 1x to 4x, a larger illuminated dot (Intelligent Variable Dot – IVD) is automatically activated to facilitate target acquisition. The luminous intensity can be adapted to the ambient light conditions with an adjustment wheel.

For 4x to 7x magnification, a fine illuminated dot is available for precise shots at greater distances, also with adjustable intensity. Whether sun, snow, dusk, or dawn – target acquisition is intuitive.



Blaser B1 1-7x28iC
magnification 2x



Blaser B1 1-7x28iC
magnification 7x



B1 2.8-20x50 iC

Compact Top Performance

Briefly explained



The B1 2.8-20x50 iC is a true all-rounder for mounting hunting, stalking, and use on a hide. It offers a large range with a compact design and is perfectly coordinated with the rifle. The 20x magnification is ideal for precise shots at great distances. With a length of 343 mm, this scope is elegant and compact. It is available with or without an inner rail and comes with Quick Distance Control as standard.



B1 4-20x58 iC

Powerful Light Transmission

Briefly explained



The B1 4-20x58 iC is a specialist for dusk and dawn and the last shooting light. It offers the best detail perception and high contrast, even in poor light conditions. The 58-mm objective delivers 7 % more light than a 56-mm objective. The up to 20x magnification guarantees shots at great distances. Equipped with an inner rail for precise mounting and Quick Distance Control.





B2

**POWERFUL.
COMPACT.
VERSATILE.**

MADE FOR HUNTING

The Blaser B2 line combines an extremely robust construction with very compact dimensions. For this reason, the B2 riflescopes are virtually predestined for the use with clip-on devices.

Versatility and Precision

The 6x zoom makes the B2 riflescopes ideal for different hunting situations. This line also provides a significant advantage when hunting at night thanks to the short length of these scopes which makes them easy to use with a clip-on device while keeping the rifle well balanced. The fine daylight illuminated dot ensures precise target acquisition while the high light transmission ensures a clear view during the day and at dusk or dawn.

Adaptability and Comfort

Thanks to intelligent add-on parts, the B2 riflescopes can be optimized for night hunting with clip-on devices. The continuous light intensity ensures easy viewing while the rubber-coated vario ring facilitates easy handling. The 90 mm eye relief provides safety and comfort.

Robust and Durable

The B2 riflescopes are robust and compact. The hydrophobic lens coating protects against water and dirt, while the nitrogen filling and watertightness up to 4 m offer reliability. These properties ensure a clear view and functional capability even in extreme weather situations.



B2 1–6x24 iC

Surprisingly Versatile: Day and Night

The Blaser B2 1-6x24 iC is versatile and ideal for day and night hunting. On a driven hunt, the true 1x initial magnification makes it possible to keep the entire shooting area in view, enabling a fast overview and reliable target acquisition. With its short and compact design, it is also ideal for use with clip-on devices.



B2 1.7–10x42 iC

Compact and Powerful: Ready for Any Kind of Hunt

The Blaser B2 1.7-10x42 iC is a versatile, compact riflescope that is suitable for all types of hunting. With a 42 mm objective diameter and a short design, it covers driven hunts, stalking, and use on a hide. The low 1.7x initial magnification offers a field of view of 24 m over 100 m for fast shots. With the CM clip-on mount and a clip-on device, it turns into the ideal riflescope for night hunting.



B2 2–12x50 iC

Universal Use: From Quick Shots to Night Hunting

The Blaser B2 2-12x50 iC is a universal riflescope with a fast 50 mm objective and 2x initial magnification. It is suitable for all types of hunting, from driven hunts to night hunting. It is compact and adaptable, with retrofit add-on parts like the QDC* for long-distance shots or the CM clip-on mount for using clip-on devices. A true all-round riflescope for any situation.



B2 2.5–15x56 iC

Fast and Accurate Detail: Ideal for Hides and Night Hunting

The extremely fast Blaser B2 2.5-15x56 iC riflescope is highly versatile. It is suitable for use on a hide, long-distance shots in the mountains, and night hunting for wild boar with clip-on optics. It was optimized for best possible detail rendering in poor light conditions.



B2 3–18x50 iC QDC⁺

Highly Reliable: for Shooting Over Long Distances

With up to 18x magnification, the B2 3-18x50 iC QDC⁺ is ideal for long distances. The included QDC⁺ enables fast and precise adjustment of the shooting distance. With a length of 337 mm, it is also perfect for night hunting with a clip-on device. In combination with a lightweight single-shot rifle like the K95, it becomes the perfect unit for mountain hunting.



THE RIGHT RIFLESCOPE FOR YOUR HUNT

Which Blaser riflescope is right for your hunting requirements?
Do you stalk at dusk or dawn, wait for wild boar in a hide with
a clip-on device at night, or hunt moving game or in the mountains?
Compare the performance parameters of our B1 and B2 riflescope
ranges and find the devices that suit you best!





Driven hunt

Day hunt /stalk

Hide / dusk

Long shots

Night hunt / Clip-on device

	Driven hunt	Day hunt /stalk	Hide / dusk	Long shots	Night hunt / Clip-on device
B1 1–7x28 iC					
B1 2.8–20x50 iC					
B1 4–20x58 iC					
B2 1–6x24 iC					
B2 1.7–10x42 iC					
B2 2–12x50 iC					
B2 2.5–15x56 iC					
B2 3–18x50 iC QDC*					

	B1 1–7x28 iC	B1 2.8–20x50 iC	B1 4–20x58 iC	B2 1–6x24 iC	B2 1.7–10x42 iC	B2 2–12x50 iC	B2 2.5–15x56 iC	B2 3–18x50 iC QDC*
Exit pupil diameter	10 mm - 4 mm	10 mm - 2.5 mm	12,3 mm - 2.9 mm	9.8 mm - 4 mm	9.8 mm - 4.2 mm	9.8 mm - 4 mm	9.8 mm - 3.7 mm	9.8 mm - 2.8 mm
Field of view at 100 m	40.8 m - 6.0 m	13.2 m - 1.9 m	9.2 m - 1.9 m	40 m - 6.7 m	24 m - 4 m	20 m - 3.3 m	16 m - 2.6 m	13,3m - 2.2 m
Eye relief	90 mm	90 mm	90 mm	90 mm	90 mm	90 mm	90 mm	90 mm
Parallax compensation	100 m fixed	50 m - ∞, 100 m arresting	50 m - ∞, 100 m arresting	100 m fix	100 m fix	100 m fix	50 m - ∞	50 m - ∞
Elevation adjustment / with QDC* / at 100 m	± 180 cm	± 230 cm, ± 80 cm	± 75 cm, ± 80 cm	±150	±145 cm	±125 cm	±125 cm	±105 cm, ± 80 cm
Windage adjustment at 100 m	± 180 cm	± 90 cm	± 50 cm	±150 cm	±145 cm	±125 cm	±60 cm	±50 cm
Adjustment per click	1 cm / 100 m	1 cm / 100 m	1 cm / 100 m	1 cm / 100 m	1 cm / 100 m	1 cm / 100 m	1 cm / 100 m	1 cm / 100 m
Weight without / with inner rail	- / 645 g	- / 770 g	- / 885 g	590 g / 615 g	680 g / 700 g	735 g / 760 g	800 g / 825 g	760 g / 795 g
Overall length	319 mm	343 mm	365 mm	273 mm	315 mm	330 mm	327 mm	337 mm
Outer diameter objective lens	not cylindrical (Inner rail)	56 mm	64,5 mm	30 mm	48 mm	56 mm	62 mm	56 mm
Outer diameter eyepiece	46 mm	45 mm	45 mm	46 mm	46 mm	46 mm	46 mm	46 mm

RD20



WITH OPEN EYES

BETTER SIGHT PICTURE. BETTER HITS.

The RD20 red-dot sight, developed specifically for Blaser rifles, offers an excellent view with minimum target blockage. The integrated Blaser Saddle Mount in a light alloy housing provides a harmonious appearance and a very low overall weight.



The RD20 is the perfect sight for rapid shots at moving game and an ideal alternative to a riflescope. With an inner diameter of 36 mm and only 3.5 mm coverage from the housing wall, it offers an excellent view. The scratch-resistant protective lenses that are almost flush with the housing, make it easy to wipe off dust, water, or snow – ideal for use in any weather. The intelligent shut-off function provides a battery life of up to 50,000 hours, so the sight is always ready for use.

RANGEFINDER

RF 8X32/10X42

One of the lightest and most compact binoculars with integrated laser rangefinder.

Easy to Clean

Quickly and easily removable eyecups for gentle and easy cleaning

Smooth to Focus for
Maximum Viewing Comfort

Convenient Operation

Measuring buttons on both sides for convenient right- or left-handed operation



Lightweight and Compact Design

for maximum comfort and a small pack size

INTELLIGENT. INTEGRATIVE. INNOVATIVE.



High-tech for Ethical Hunting

The Blaser Rangefinder app enables users to adjust settings such as brightness, units, and the measuring mode. They can call up detailed product information and technical data of the rangefinder. It is also possible to create firearm and ammunition profiles and to transfer these to the binoculars, including the ballistic calculation. These functions turn the app into an indispensable tool for precise and efficient hunting. The Blaser Rangefinder is the ideal companion, especially for hunting over greater distances. Together with the QDC⁺, it forms a perfectly coordinated unit.



Ballistics calculation:
The number of clicks to be adjusted is calculated using the measured distance, the current weather data, and the activated profile.

FBX

SIMPLY THE BEST





A NEW TAKE ON SHOTGUNS: BLASER FBX

Born out of passion for shotgun sports. Created to deliver peak performance in competition. The Blaser FBX sets the highest standards. Its architecture is a symphony of optimally aligned components making it the perfect shotgun for demanding sports shooters and hunters.





“A masterpiece of
shotgun making!”

András Szerdahelyi (HU)

Multiple World and European Champion and Grand Prix Winner András Szerdahelyi is one of the top shooters in the international sporting clays scene

Intuitive Perfection

The extraordinary balance and weight distribution of the Blaser FBX allow for optimal swing characteristics and fatigue-free shooting. Essential for this is the Fat Body receiver with semi round contour which guarantees a stable center of gravity on the hinge pin. Due to its balanced overall composition shooter and shotgun become one.

Gentle Powerhouse

The advanced stock geometry of the Blaser FBX is complemented by a soft recoil pad with large contact surface. Together with the FBX' optimized weight distribution, this significantly reduces felt recoil. The geometry-driven linear recoil design minimizes muzzle flip for seamless second target acquisition.

When Moments Count

The combination of excellent trigger characteristics and inline hammers enables particularly fast, intuitive firing. The proven Anti-double system (Inertial Block System® – IBS®) allows for a lightweight trigger.

FBX



Optimum Shot Guidance

The sophisticated barrel geometry of the Blaser FBX ensures maximum velocity of the shot, an optimized pattern, and recoil reduction. The barrels are available either with new extended thin-walled multi chokes or fixed chokes. The ventilated side rail improves barrel cooling and reduces the weight of the barrels, which results in a better balance of the shotgun.

Ideal Swing Characteristics

A new balancer system is integrated in the fore-end of the Blaser FBX. This allows the weight distribution to be customized to shooter needs. The low center of mass enables improved shooter control for reaction without delay.



Experience the
FBX now!

Pleasant Shooting Experience

The special stock geometry and large contact surface of the recoil pad result in less felt recoil. Due to the vertical geometry of the pistol grip, the firing hand assists in recoil management, reducing the impulse felt at the shoulder. Thanks to the balancer system integrated in the butt stock, the balance of the Blaser FBX can be adjusted according to personal preferences.



Elegant Durability

The DLC coating (Diamond Like Carbon) in elegant black on all visible steel surfaces, including barrels, receiver and trigger guard, provides exceptional hardness and industry leading corrosion protection.



Performance and Reliability

The modern Fat Body receiver combines a traditional design with optimum balance and stability. The integrated Anti-double system IBS® and the Ejection Ball System EBS® provide reliable function and a smooth, fast, and seamless reload. The receiver in monocoque design with detachable trigger unit allows for easy maintenance.



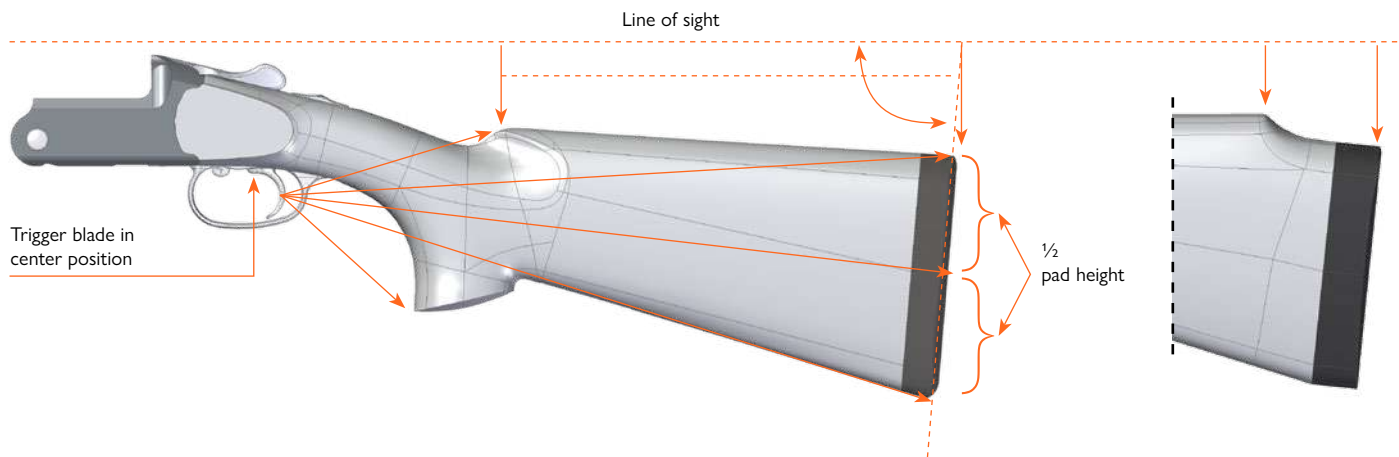

STOCKS MADE TO HIT

Your exclusive custom shotgun stock is as individual as you are and creates the optimal basis for your success – whether on the hunt or in shooting sports. A shotgun with a custom stock provides maximum shooting comfort, higher accuracy, and a much more comfortable recoil sensation. The perfectly adapted stock allows for a return to zero shooting position, relieves the muscles and makes fatigue a thing of the past during competition or training.

Perfection in Isny

Accompany us during the exciting manufacturing process of your stock at our factory in Isny. With a trained eye, our specialists measure six dimensions – stock length, drop, cast, pitch, grip length and palm swell – analyze your data, and transfer it directly to a model stock. The model stock which is processed using state-of-the-art CNC milling technology and afterwards finished by master craftsmen, can then be put to the test in our indoor shooting range. In the Blaser Custom Shop's stock selection showroom, you will have the unique opportunity to select your personal stock wood and to grasp the beauty of the material with all your senses. By choosing the piece of wood in the desired grade, the final custom stock eventually acquires its unmistakable character and your very personal touch. We will store your personalized model stock for you after completion, so that you can have further custom stocks made at any time.

Customization worldwide

If it is not possible for you to come here, our experienced authorized dealers worldwide will measure you to order your custom-made stock from us. The four dimensions of stock length, drop, cast and pitch result in the individual 4D custom stock for your shotgun. We will then manufacture your personal custom stock based on the measurements provided and the stock wood grade of your choice, without any long delays.



CUSTOM STOCK



Champion AND Gentleman

For decades the British shooter John Bidwell has been one of the most successful shotgun shooters in the international sporting scene. As a world-renowned master of his trade, he has been involved in the development of the Blaser F3 over-and-under shotgun from the very beginning. Since its market launch, John Bidwell has won a total of six world championship titles with the F3 in addition to a whole series of podium places, most recently in Malaga, Spain, in 2024.

Today, John Bidwell's second passion is to shoot alongside talented individuals that he supports with advice as they take part in majors.



“To be on the winners' podium, you have to compete with the intention of winning. Of course, this doesn't always work, but self-confidence and the determination to win are just as important as a first-class shotgun.”



“I took part in countless competitions with my first F3 and won several world championship titles. After a few 100,000 shots, I left it to my grandson, who is sure to enjoy it for a long time to come”

The High Lodge shotgun course is approximately two hundred kilometers north-east of London, not far from England's east coast. John Bidwell can be found there almost every day. He built this course on his own initiative and has constantly expanded it with great attention to detail. High Lodge is his life's work, which is now known far beyond England and is one of the most beautiful and challenging courses of its kind.

At the age of seventy-six, John still takes part in majors, but it has become his second passion to support the younger shooters in particular Georgia Moule whom he has coached at High Lodge previously. The F3 shooter has already taken first place five times at the Ladies British Open thanks to John's expert support and has even won gold, silver and bronze medals at world championships, among many other successes. And F3 shooter Will Page, who is only seventeen and at the beginning of his shotgun career, is already showing so much talent that John predicts an equally successful future for him.

However, it is a particular pleasure and satisfaction for John Bidwell that his fourteen-year-old grandson seems to have inherited his passion for shotgun shooting and is now shooting his original F3. John looks forward to seeing his name continue to appear on the winners list in the future.



F3

THE SHOTGUN THAT ANSWERS TO THE HIGHEST DEMANDS

In competition the F3's technical superiority will outperform all others. When hunting the F3's outstanding pointability and balance will be no match for any game. Designed for intuitive shooting in terms of ergonomics and technology, the F3 has been programmed for success in any terrain for more than two decades.



Reinforced Firing

Designed for steel shot.

Blaser Balancer System

Enables flexible adaptation: swing-through, pull-away, sustained lead, and move-mount-shoot. Consists of a butt-stock balancer and a barrel balancer.

Triplex® Bore Design

Three design features optimize muzzle velocity, shot string homogeneity, and recoil damping.

F3 Competition

Ideal for a variety of competitive disciplines, including Sporting, Compak Sporting and Olympic Skeet shooting. All competition barrels can be used with the barrel balancer system and are almost identical in terms of weight, balance and swing characteristics. The sporting stock with pistol grip and palm swell encourages a relaxed hand position during target acquisition.

- **Gauge:** 12/76; 20/76; 28/70; .410
- **Barrel:** 71 cm, 76 cm or 81 cm (28", 30" or 32")
- **Sight:** HIVIZ® shotgun bead kit
- **Weight:** From approx. 3.6 kg (7lb. 15 oz.)



Blaser EBS® – Ejection Ball System

The ejection system tensions the ejector springs only when the lock is released, ensuring a constantly low resistance when the shotgun is fired.

Blaser IBS®: Anti-Double System

Reliably prevents inadvertent triggering of a second shot.

True-left

All models are available with a left-handed receiver and left-handed stock.

Optimal Hinge Operation

Extremely soft hinge operation for full focus on aiming.

Linear Guidance of Firing Pin

Maximum use of energy and short ignition delay time.

Solid Locking Wedge

Maximum locking reliability thanks to solid breech block and pressure plate.

Minimal Strain on the Locking Mechanism

Optimum geometry reduces strain on the locking mechanism and maximizes the service life.

Blaser F3 Trigger

The trigger of the Blaser F3 breaks “crisp” at 1,500 grams with extremely short travel. The barrel selector conveniently positioned in front of the trigger allows the shooter to select the preferred shot sequence. The length of the trigger blade can be continuously adjusted and is optimally positioned in the force direction of the shooting finger.



Create your individual F3!



Sight: HIVIZ® shotgun bead kit



Barrel: Mid Rib in 76 cm
or 81 cm (30" or 32")

Sight: Mid bead and front bead



Barrel: High Rib in 76 cm
and 81 cm (30" and 32"); set
in the factory to a pattern
70:30 (sighting plane "figure 8")

Sight: Mid bead and front bead



Barrel: High Rib O&U barrel
in 81 cm (32"): set in the
factory to a pattern of 70:30
(sighting plane "figure 8")
USGL barrel 86 cm (34"):
set in the factory to a
pattern of 85:15 (sighting
plane "figure 8")

F3 Vantage

The raised rail in connection with the perfectly adapted stock ensures faster aiming and appreciable relief for neck and shoulders. The flat ramp angle additionally expands the peripheral view, completely independently of the altitude of the clay and the angle to the target.



Weight: From approx. 3.8 kg
(8 lb. 6 oz.)

Gauge: 12/76; 20/76

F3 Supersport

The F3 Supersport is the specialist choice for F.I.T.A.S.C., English and American Sporting shooters and is also becoming an increasingly popular choice for successful Olympic Trap competitors.



Weight: From approx.
4.0 kg (8 lb. 13 oz.)

Gauge: 12/76

F3 Supertrap

The harmonious combination of total length, balance and weight distribution makes the F3 Supertrap the ideal companion for champions, whether as an over/under (OU), Under-Single (USGL) or an F3 Supertrap Combo (OU + USGL) version.

Thanks to the large adjustment range of the rib, demanding trap shooters can use the F3 to its full potential and adjust the shot placement by raising or lowering the rib according to their individual requirements.



Weight: From approx. 4.0 kg
(8 lb. 13 oz.)

Gauge: 12/76 (O&U)
12/76 (USGL)



Grand Luxe

A partridge and pheasant with elaborate details adorn the receiver of the F3 Grand Luxe. The deeply engraved animal motifs are embedded in leaf arabesques. The stock with wood grade 6 turns the shotgun into an elegant companion.

F3 Competition Grand Luxe with hunting animal images

MODEL VERSIONS



F3 Competition Baronesse with hunting animal images

Baronesse

Stylish engraved long side plates are the outstanding feature of the F3 Baronesse. Duck and pheasant or fine scroll arabesques can be selected for the engraving. Exquisite walnut wood with wood grade 7 and a gold-plated trigger complete the noble look.

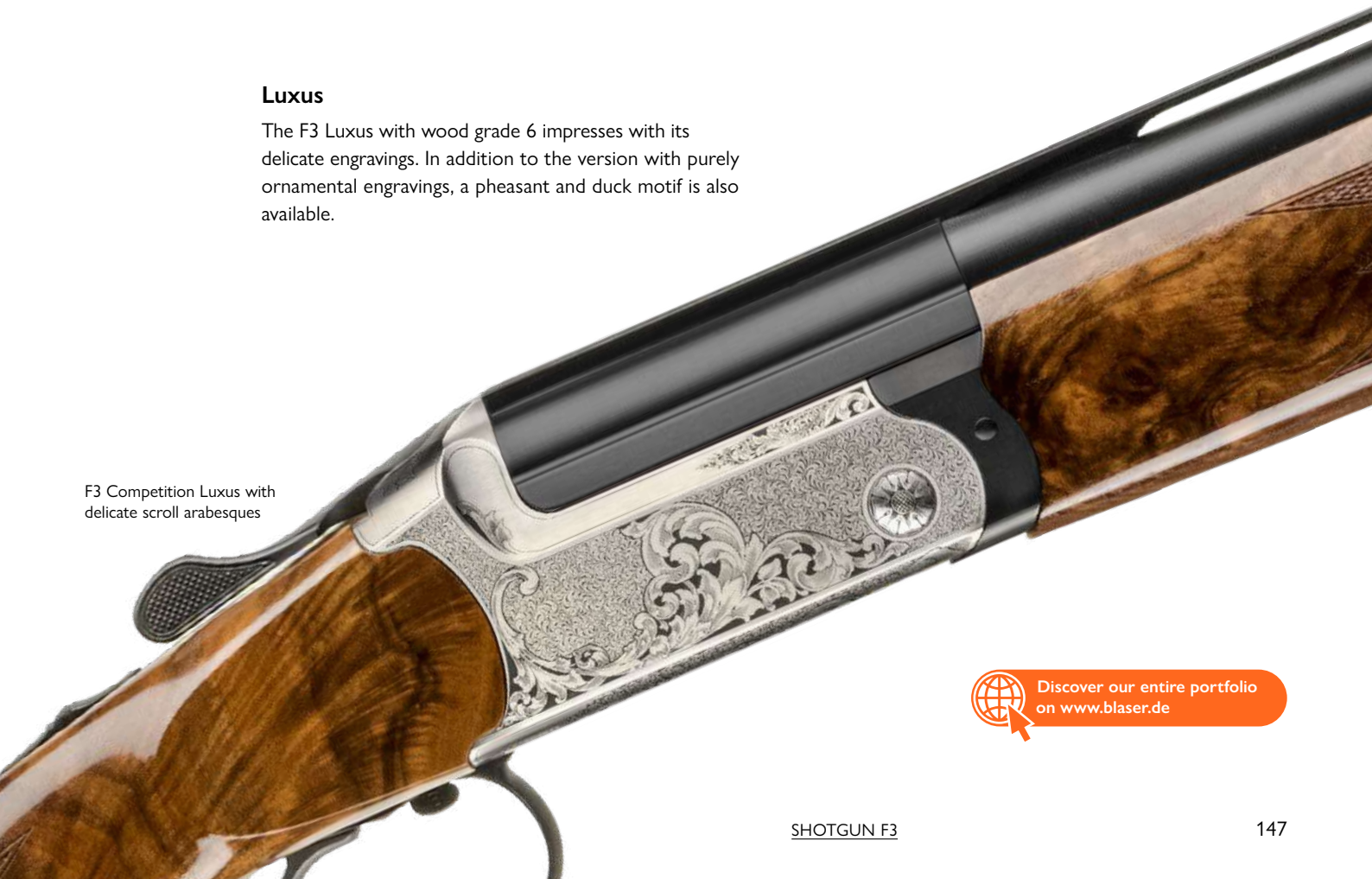

F3 Competition Luxus with delicate scroll arabesques

Luxus

The F3 Luxus with wood grade 6 impresses with its delicate engravings. In addition to the version with purely ornamental engravings, a pheasant and duck motif is also available.



Discover our entire portfolio on www.blaser.de



A DREAM SHOTGUN IN GOLD AND SILVER

Timeless elegance meets exclusive details – this F3 Custom is the epitome of classic hunting shotguns and an homage to hunting game birds. The delicate English scroll filling with lively leaf arabesques perfectly frames the repeated pheasant motifs. These birds, which were once kept in royal menageries, are portrayed on the receiver and the trigger guard. The shotgun also owes its special look to the exquisite bulino engraving technique, which highlights even the smallest details, depending on the lighting and angle, as well as to sumptuous gold and partially raised silver inlays. The high-quality, grade-11 stock wood completes the elegant appearance. Could this be your inspiration to make your very own shotgun dream come true, together with our experienced engravers and gunsmiths?

Please do not hesitate to contact us.



On the F3 “The Dark Night” Custom shotgun, master engraver Daniel Karagiannis exquisitely played with the theme of gambling and luck. Like a script, the shotgun features all the elements of a tense thriller, including a well-measured dose of evil. One of those is the Joker face we all know from the films, ingeniously engraved on the underside of the trigger guard. Temptation also makes an appearance – on the right-hand side of the receiver: With great attention to detail, the lascivious lips of the queen of hearts and words of love in the background are combined with almost three-dimensional dice inlaid in fine silver over the playful art nouveau ornaments. The left-hand side of the receiver is dominated by the ace of diamonds and a skull. Instead of the dice, Daniel Karagiannis here chose three-dimensionally silverplated poker chips as a symbol for the world of gamblers. Skulls with flaming eyes on the underside of the receiver give an entirely new meaning to the roulette expression “no more bets – nothing else goes”.

As a whole, “The Dark Night” celebrates a rather gloomy side of gambling, but in such an impressive artistic manner that the shotgun automatically draws in the observer and holds them spellbound. Full of tension and deep emotions, this unique F3 is certainly a big win.

LUCK IN ONE HAND

COMPETITION

COLLECTION





MADE FOR COMPETITION

Do you feel at home on the shooting range? Are you at your best during competitions? With the Blaser Competition collection, we offer you the support you need when it really matters. Lightweight, breathable materials with a high stretch content provide an optimum body climate and maximum freedom of movement and reliably keep out sun, wind, and rain – leaving you to concentrate on what really counts: the next clay.



Contastant 2.5L Jacket Lightweight and minimalistic 2.5L Jacket – fully weatherproof.



Argali Mesh Snapback/Argali Denim Snapback Baseball cap with Argali logo, mesh insert at the back, and snapback size adjustment.
Competition Polo Shirt 23 High-performance polo shirt made from fast drying fabric in different colors.
Competition LS Base Layer 23 Long sleeved base layer made of cooling blended fabric for maximum comfort even in warmer weather. Available in White and Competition Orange.
Competition Vest Fully featured shooting vest for left-handed and right-handed shooters – great breathability and full freedom of movement!



Sight

Nickel-silver pearl bead 3 mm
(0.12")

Barrel

71 cm or 76 cm
(28" or 30")

NEW

Selected variant now also available in
caliber 20/76.

Reinforced Firing

The F16 has been designed from
the ground up to use steel shot.

Rib

9 mm, tapering to 7.5 mm

Triplex® Bore Design

Three design features optimize muzzle
velocity, shot string homogeneity, and
recoil damping.



Sight

Red bead

Barrel

76 cm or 81 cm
(30" or 32")

F16

Perfection from passion – the F16 is the result of engineering skill and experience. Equipped with the lowest receiver in its segment, it represents its very own shotgun category for hunting and sporting. Its unique handling, which in combination with other essential features, significantly improves successful intuitive shots, making it the perfect shotgun for hunters as well as for ambitious skeet shooters.

Receiver

In Gun Metal Grey with silver-colored F16 logo

F16 GAME

Blaser EBS® – Ejection Ball System

The ejection system tensions the ejector springs only when the lock is released, ensuring a constantly low resistance when the shotgun is fired.

Blaser IBS®: Inertial Block System

Reliably prevents inadvertent triggering of a second shot.

Blaser F16 Trigger

The trigger of the Blaser F16 is impressively crisp. The very short trigger delay time converts the thought impulse into the triggered shot within a fraction of a second. The barrel selector conveniently positioned in front of the trigger allows the shooter to select the preferred shot sequence.

True-left

All models are available as left-handed versions.

F16 SPORTING

Barrel Balancer

Prepared for use of balancer weights on the barrel

Receiver

In Gun Metal Grey with red F16 logo

Trigger Blade

The length of trigger blade of the F16 Sporting can be continuously adjusted and is optimally positioned in the force direction of the shooting finger.

Balancer in stock



Create your individual F16!



F16 Game Luxus with hunting animal images

Luxus version

The receiver of the F16 Luxus is adorned with elaborate leaf arabesques in the traditional "Basso relief". These embellishments can be combined with delicate English arabesques or hunting motifs on request. The forearm plate, trigger guard, and opening lever are kept in elegant black. The exquisite Caucasian root wood with wood grade 5 completes the exclusive appearance. The F16 Luxus is available as an F16 Game or Sporting, in a left-handed version, and optionally with an adjustable comb.



F16 Luxus with delicate scroll arabesques

See the F16 in Action





F16 Baronesse with delicate scroll arabesques

Baronesse version

Delicate, sumptuous leaf arabesques in the traditional “Basso relief” adorn the long side plates of the F16 Baronesse. Hunting motifs can be added to the delicate arabesques on request. The exclusive stock wood with grade 6 completes the elegant appearance. The F16 Baronesse is available as an F16 Game or Sporting, in a left-handed version, and optionally with an adjustable comb.



F16 Game Baronesse with hunting animal images



Discover our entire portfolio
on www.blaser.de



INTUITIVE. ELEGANT. PERFECTLY BALANCED.

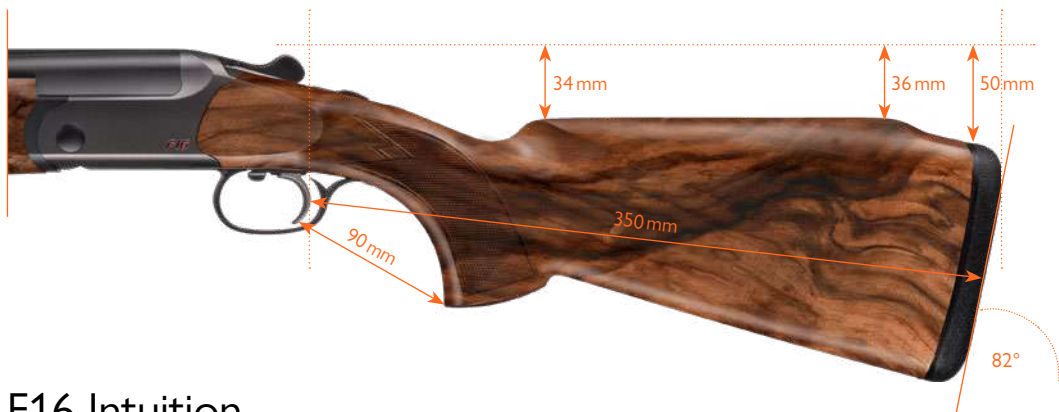

F16 Intuition

Shooting with female intuition was our inspiration to develop a shotgun exclusively for women. With the lowest profile receiver in its class, the F16 forms the ideal basis for a shotgun that is perfectly tailored to the needs of women – both for hunting and clay shooting.

Thanks to reduced pitch angle and slender pistol grip, the optimized Monte Carlo stock rests naturally in the shoulder and ensures positive trigger control. Shooting becomes more comfortable. The F16 Intuition versions boost self-confidence and lead to natural, intuitive shooting. Huntress and shotgun instantly become one. The F16 Game and F16 Sporting are available as F16 Intuition.

LADIES' CHOICE.





CLASSIC
COLLECTION

Traveller Hat The classic made of exquisite merino wool! Versatile for use in sun and even rain. Water resistant thanks to 100% merino wool.

Vintage Wing Jacket Classic Wing Shooting jacket with unique Blaser styling. Boasts easy access pockets and full weather protection.

Vintage Flat Cap Stylish flat cap made from elegant Blaser Vintage fabric. **Vintage Wing Vest** The Wing Vest completes the Wing Shooting outfit and is designed to be worn on its own or in conjunction with the Wing Jacket. **Shirt Tristan 22** Checkered hunting shirt for a stylish look. **Merino V-Neck Sweater** Merino V-Neck Sweater – elegant sweater made of 100% fine merino wool (non-mulesing).



HUNT IN STYLE

Living the hunting lifestyle – in all its facets. Our classic clothing line blends cutting-edge fabrics with traditional style elements. Whether it is on the hunt or in everyday life, it will give you the necessary freedom for the challenges to come – in all weather conditions and in any terrain.



Insulation Jacket Eve Water repellent thermal jacket with hood. An elegant look with feminine quilting and lines. Melange stretch outer fabric for freedom of movement.

Blouse Charlotte Stylish blouse made of super soft flannel material with check pattern.

Discover
Blaser CLASSIC!





Merino V-Neck Sweater Merino V-Neck Sweater – elegant sweater made of 100% fine merino wool (non-mulesing).
Shirt Tristan 22 Checkered hunting shirt for a stylish look.

Wool HZ Sweater All-around half-zip wool sweater. Warm enough to be worn on its own or under a shell jacket. **Shirt Tristan 22** Checkered hunting shirt for a stylish look.

Rib Beanie Bob Modern beanie with a ribbed structure and wide fold-over. **Insulation Vest Eve** Elegant thermal vest with feminine quilting. Increased freedom of movement thanks to melange stretch material.
Blouse Charlotte Stylish blouse made of super soft flannel material with check pattern.





left: **Traveller Hat** The Blaser hat is a true classic. Made of exquisite merino wool! Popular for its versatility: great as sun protection or to keep off the rain. **Insulation Shacket Ron** Sporty and casual lightweight insulated jacket for everyday. **Canvas Pants Patrice** Full casual look and full comfort for any occasion. Center left: **Jacket Milana** Stylish quilted jacket with a classic look. Weatherproof, warm, and water repellent. **Canvas Pants Patrizia** The Patrizia Canvas Ladies Pants combine a casual look with added comfort. Center right: **Insulation Vest Ian** Classy insulated vest with fine Suede trimmings. Melange stretch outer fabric for natural look and combines nicely with Blaser shirt range. **Suede Pants Maddox** Modern styling Suede pants with full weather protection. Perfectly matches many of the Vintage or Suede based jackets and vests. right: **Casual Jacket Leonie** Stylish, weatherproof quilted jacket. An elegant look for the hunting lodge or the city.



left: **Traveller Hat** This stylish classic made of merino wool protects against sun and rain. **Vintage Radiation Down Jacket** Super warm Vintage down jacket with Suede detailing for a stylish look. Primaloft® Rise maximizes heat retention and thus provides super warmth comfort in very cold conditions. **Vintage Pants Ake 22** Functional pants with full weather protection. Made out of super soft Vintage fabric featuring reinforcements in high abrasion zones. right: **Rib Beanie Bob** Cool beanie with ribbed structure keeps you warm on cold days. **Vintage Coat Celine** Full weather protection and a stylish look. Made of exclusive vintage material, the coat looks just as great in everyday life as it does on a hide in winter. It keeps you warm and repels water, it is low noise and is equipped with a special pocket system for hunting. **Vintage Pants Celina** Warm Pants with full weather protection and a feminine cut. Perfect in combination with the Celine Coat.

FOR COLD DAYS IN THE FIELD



Shirt Louie Everyday function flannel shirt in check design. Mixes and matches across the entire Classic line. **Vintage Pants Ake 22** Warm, weather resistant functional pants; low noise and water repellent. Particularly durable thanks to the reinforcements in high-wear areas.

SHARP HUNTING COMPANIONS



Ultimate Carbon Line

The knives from the Ultimate Carbon range are made of high-quality carbon steel. They feature excellent edge retention and yet are lightweight. The design based on the Blaser carbon stocks gives this knife line a stylish look.



Prestige 110

The Blaser Prestige Knife 110 is a classic hunting knife with an elegant handle made of walnut wood. The drop-point blade shape is characteristic of its versatility. Ideal for opening game as well as for the subsequent processing of the meat.

KNIVES

Wherever you are out in nature, the Blaser knives are essential companions – when camping, fishing, or hiking, or on a hunt, where game has to be cut precisely or an injured animal has to be killed.

Professional Line

Ready for any hunting situation with the Blaser Professional 110 and the Skinner Professional 110. The modern design is durable and robust. The full-tang design, with the blade and handle made from a single piece of steel, ensures exceptional steadiness during cutting and gutting.



Classic Line

The knives from the Classic range impress with their elegant and timeless design. The flexible all-rounders with drop-point blade are ideal for all outdoor and hunting activities. The elegant appearance is completed by the round blade and the walnut handle.





Blaser

Blaser



Robust, versatile, powerful – whether for orientation outdoors, when retrieving game, or for everyday use at home, in the car and outside – the new Blaser flashlights and headlamps reliably light up the dark.

Best visibility also for your four-legged companion – discover now at www.blaser.de

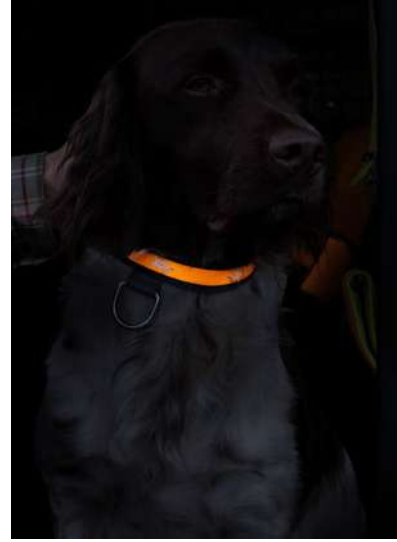

EDL Range

Made for use in any situation: the “Everyday Light” EDL range. The individual flashlights primarily differ in size and beam length and feature a robust aluminum housing, different light modes and the slender Blaser design. The ideal companions for at home, in the car, hiking, camping, or stalking!



LIGHTS

HL Range

The powerful “Hunting Light” HL range with robust aluminum housing in Blaser design – developed and optimized specifically for hunting! Different white-light and red-light modes support different applications: While the reduced red-light mode does not startle the game unnecessarily and supports the night vision capability of the human eye, the white light provides illumination where it is needed. Available in different sizes and with varying lumen levels.



HT Range

Free hands and a good view with the lamps from the “Head Torch” range! Compact, lightweight, and versatile, these models are suitable companions for all hunting and outdoor activities. Available in different versions.





BACKPACKS



Canvas Backpack

The Blaser Canvas Backpack combines functionality and elegance, offering you a stylish and convenient way to transport your equipment. Ideal for hunters and outdoor enthusiasts with the highest demands for quality and design.



Seat Backpack

The Blaser Seat Backpack is the ideal combination of comfort and functionality for passionate hunters. The aluminum frame can support up to 140 kg. The backpack can quickly be converted from a spacious transport option into a seat, whenever and wherever needed.



Competition Range Bag

The Blaser shotgun backpack offers first-rate comfort and organized storage for hunters and sport shooters. The sturdy, pre-shaped base section ensures good stability. Clever openings enable you to transport your shotgun between the carrying system and the main pack. Available in brown and blue.

One basis, many options: The Ultimate Backbone system forms the stable foundation of the Blaser Ultimate Backpack range. As a modular system, it can be combined with the Ultimate Backpack S or M and with the rifle holster, offering a number of flexible transport and packing solutions.



Ultimate Backbone System

Ultimate Backpack S, Ultimate Backpack M, or Ultimate Rifle Holster – the individually selectable backpack components can be easily and flexibly attached to the base of the backpack – the Backbone carrying system. Thanks to the height adjustment and the ergonomic shoulder straps with a chest strap, the Backbone carrying system can be perfectly adapted to the wearer. The internal aluminum frame ensures optimum load transfer, while the soft back padding offers added comfort. The Backbone system is additionally equipped with a safety whistle.

DREAM DESTINATIONS ALL OVER THE WORLD

Discover the fascinating world of hunting trips and fulfill your dream of traveling to distant hunting grounds! According to the motto “quality before quantity”, we concentrate exclusively on hunting areas where we have hunted ourselves. We work exclusively with outfitters and professional hunters whose first responsibility is to the wildlife, and whose understanding of hunting is in line with ours: fair chase and sustainability.



AFRICA

Mauritius

Hunting on the Island of Your Dreams

Experience a dream holiday on the Indian Ocean and exciting hunting: If you suggest Mauritius as a destination, you'll find it won't be too difficult to persuade your partner to come with you for a hunting holiday. After all, where else in the world can you combine a relaxed beach holiday with hunting?

Mozambique

Buffalo Fever in the Zambezi Delta

Mozambique, in southern Africa, offers you the chance to experience wilderness unchanged for millennia. This is one of the greatest hunting countries on earth: There are special areas reserved that have had no hunting pressure for 16 years.

Zimbabwe

In Colonial Style

Hunting in Zimbabwe is done with our partner in the Matetsi region in the west of the country. These areas are the Kazuma/Pandamasuie Forest area which borders the Kazuma Pan and the Zambezi National Park.

Other hunting areas are near the Fuller Forest and further south in the Ngamo forest areas. None of the areas is fenced, so the game is free-range, and all areas are known for their very good game populations, with mature trophies.



South Africa

Africa's Diversity

Safaris are run in South Africa throughout the year, with the best hunting opportunities between April and October. Around 40 different species of game can be hunted throughout the country, and each safari is carefully planned by us to suit your wishes. Safaris in South Africa are suitable for the whole family and for the non-hunters in the party, there are a variety of interesting photographic tours.

Other hunting countries in Africa:

Cameroon, Ethiopia, Tanzania, Uganda, Zambia



Discover more hunting adventures here!



ORIGINAL AND HONEST STALKING

Namibia

Sney Rivier Lodge

Hunting fever can affect everyone: whether you are carrying a camera, binoculars or a rifle, being near wild game will send your pulse racing!

Experience the unique flair of Sney Rivier Lodge, which is just a two-hour drive from Windhoek airport. In a breathtaking landscape, you can hunt more than 20 game species, while stalking exclusively on foot. Thanks to a wide range of leisure activities, non-hunting partners will surely also enjoy the stay.

Situated in the landscape at the base of the Khoma Highlands, Sney Rivier Lodge enjoys a unique ambience. The architecture and design of the lodge is inspired by nature and hunting. The boundaries between inside and outside are blurred. Within view of the main house and the guest chalets is a watering hole where game can be observed all day long.

The lodge is the ideal destination for both the experienced African hunter as well as for those hunting on the continent for the first time. The trip will be an unforgettable experience for the rest of the family, too. From the generous breakfast buffet to delicious dinners, the chefs are always able to surprise with a combination of traditional African and modern international cuisine. Sney Rivier Lodge pampers you with the highest levels of luxury, while being in the middle of the Namibian bush. This trip is also sure to be an unforgettable experience for accompanying family members.

Hunting challenges are guaranteed to be found on the almost 100,000 acres of hunting grounds, be it tracking wild game and stalking to within range of your quarry or sitting in a hide on one of the countless rocky hills. Our hunting guides and trackers are masters at helping you, the hunter, succeed. As skilled connoisseurs of flora and fauna, they are able to show you some of the most extraordinary natural wonders in Namibia.



EUROPE

Croatia & Serbia

Hunting with a Sea View

Croatia offers a unique combination of broad hunting opportunities with a Mediterranean flair. It is a lifetime experience to shoot mouflon or chamois in the rugged and rocky “karst area” along the picturesque Dalmatian coast. In the inland of Croatia, near Rijeka, an adventurous hunt for bear awaits you. Our partner Pavle, will care for you – around the clock.

Serbia is a country with an ancient hunting tradition. Either hunting roebucks in spring in the famous Voivodina or in the summer months during the rut, it is always an unforgettable experience for our guests. You can hunt in popular territories like Subotica, Kanjiza, Novi Knezevac and Kumane. In top areas like Bascki Monostor, Apatin and the Serbian inland in Pancevo you can hunt impressive stag during the rut.

Austria

For the Whole Family

Climbing from the flat country to hunt in the mountains is not the only aspect of hunting in Austria that holds a special thrill. To be able to spend the whole day stalking chamois in the spectacular Alpine scenery is a thoroughly enjoyable change for most hunters, who can only hunt in this type of terrain in the twilight hours at home, if at all. What's more, there are few places outside the beautiful Austrian Alps where you can combine hunting with a family holiday with just a few hours driving.

Whether you choose to start your hunt from a cosy guesthouse, a holiday apartment or a stylish hunting lodge, you will always be impressed by Austrian hospitality and the knowledge and experience of your hunting guide.

Blaser Safaris organizes hunts in:

Carinthia Drautal, Carinthia Maltata, Tyrol Seefeld, Galtür

Scotland

Mystical Highlands

Hunting red deer in the Scottish Highlands is an almost legendary experience. With their deep valleys, steep slopes, crystal-clear rivers and lochs, the Highlands of Scotland have qualities of solitude and remoteness that are found almost nowhere else in Europe. Here you can stalk red deer all day long, and trophy fees are not high. Memorable hunts are the result of the skill and fitness of the hunter and his guide rather than the size of one's wallet.





Spain

In the Land of the Ibex

Hunting for ibex is the crowning glory in Spain – and there are four different subspecies on the Iberian Peninsula. The Gredos ibex is found in the Sierra de Gredos, which lies around 200 km west of Madrid. It is the most well-known of the four species. The others are the Beceite ibex, from the Beceite mountains north of Valencia; the Sierra Nevada ibex from Andalusia; and the Ronda ibex from the Ronda mountains.

All four species are highly desirable trophies. The hunting season for all four ibex species runs from October to the end of May. Hunting during the rut from the middle of November to the middle of December is highly recommended, or from April when bucks group together in small packs.

Along with ibex, Spain also offers opportunities for combined hunts, having good stocks of red and fallow deer, chamois and aoudad sheep in its various regions.



Additional hunting countries in Europe:

Bulgaria, Czech Republic, England, Estonia, Finland, Ireland, Greenland, Italy, Romania, Sweden, Slovenia, Slovakia, Turkey

Discover more hunting adventures here!







Hungary

Europe's Hunting Paradise

Hungary offers a unique variety of hunting opportunities with red deer, roe deer, mouflon, fallow deer and wild boar all available. The country's exceptional game stocks and its hospitable people attract numerous visitors who come to enjoy Hungary's large selection of national hunting areas and comfortable hunting lodges.

Hungary is a fantastic country in which to hunt roe deer, which can be found in both the east and the west. Strong bucks are mainly found in eastern Hungary, where you can choose between stalking and high seat hunting. In western Hungary, with its extensive hunting areas, there is also excellent roe buck hunting to be had.

Since the start of the 20th century, Hungary has also been renowned for its classic small game hunting (driven or stalking). Hunters from across the globe visit the Hungarian lowlands in the east of the country every year.

Red Deer Rut

There is no better time or place on earth to hunt such enormous stags than here in Hungary during the rut. The noblest of our game species is nurtured with great care here in Hungary where its natural habitat is still spacious enough. For most hunters the red deer rut is the biggest highlight of their hunting year.

Especially in our national hunting areas, rangers work towards the rut throughout the year, and thus make hunting all classes possible.

Mouflon and Fallow Deer

Hunting mature mouflon rams in the indigenous and hilly oak and beech forests of Hungary is particularly exciting.

Hungary is world-renowned for being one of the best countries in which to hunt big fallow stags: from interesting, abnormal stags to world-record class.

NORTH- & SOUTH AMERICA

Alaska

Rough Coasts and Strong Bears

Admiralty Island, situated in the middle of the inside passage of Alaska's wild coast, boasts the largest density of brown bears per mile.

Enjoy the natural beauty of Alaska against a stunning backdrop. It is not uncommon to see whales, eagles, seals, sea lions and a number of other animals. All trips include fishing. A superbly equipped yacht provides you with comfortable accommodation, and you'll be travelling along the most remote stretches of coastline, using a rubber dingy to approach the areas that have the greatest promise for success. The chance of bagging a really substantial coastal brown bear is unusually high here, and there is also the possibility of hunting wolves and black bears.



Canada

Every Hunter's Dream

Canada's northern provinces of British Columbia, Yukon and the Northwest Territories have been spared from the effects of civilization, making them the ideal terrain for a hunting trip. The north of Canada offers you much more than just moose hunting. Spring is one of the best times to hunt black bears. August is ideal for a very demanding Dall sheep hunt, or to pursue snow goats. The stalks for old caribou bulls starts in the high valleys in September, while the moose rut begins in the middle of that month.

The commercial hunt for caribou, musk ox, polar bear and walrus is one of the Inuit's few sources of income all the while managed under government regulations and hunting quotas to ensure absolute sustainability. Regardless of where you hunt, this will prove to be one of the most unique hunting expeditions of your life; experience the high north.

Blaser Safaris organizes hunts in:
North and South British Columbia, Vancouver Island, Nunavut, Saskatchewan & Alberta, Newfoundland

Additional hunting countries in North & South America:

Argentina

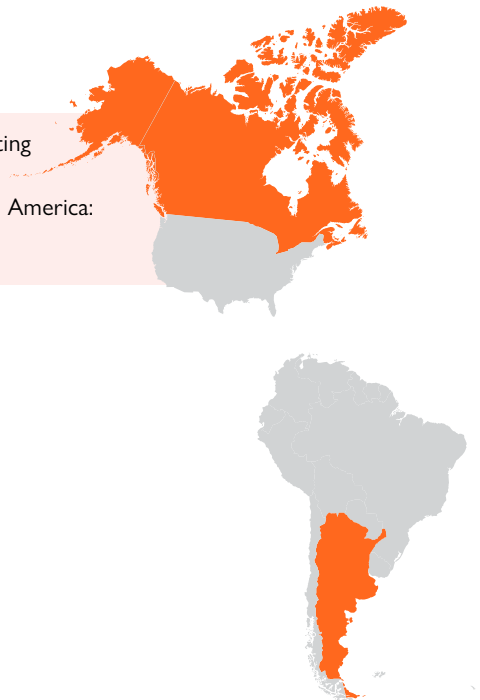

AUSTRALIA & NEW ZEALAND



Australia

The Fascination of Down Under

Hunting is a special experience in Australia and will surprise even the most experienced and well-travelled hunters. Along with water buffalo, which our partner specializes in, you can also hunt banteng and wild boar. Accommodation is in comfortable tented camps near the hunting areas.



New Zealand

At the Other End of the World

This truly is one of the most impressive hunting areas in one of the most beautiful countries in the world. Exceptional examples of game species and fantastic landscapes have established New Zealand as one of the destinations for the globetrotting hunter. Conscientious management and a limited number of hunts ensure the highest quality of this outfit and helps to preserve it from season to season.



FEATHERED GAME HUNTING WORLDWIDE

A large variety of species and beautiful countrysides make our feathered game hunting destinations all over the world an unforgettable experience. Feel well taken care of: Our partners know the best hunting areas and the optimal hunting season. Look forward to country-specific hospitality and the exchange of experiences with other hunters in the relaxed atmosphere of our comfortable accommodations.

Feathered game hunting destinations:
Argentina, Czech Republic, Hungary, Ireland, Scotland, Spain, South Africa, Tanzania

Please note that there is also a good choice of activities and exciting sights for non-hunting companions in most countries.

YOUR INDIVIDUAL TRIP. ANYTHING IS POSSIBLE.



Do you have another destination in mind for your hunting trip? Simply contact us. We have many other fantastic hunting destinations in our portfolio. Our experienced team of travel experts can advise you and help you design your adventure exactly as you want it. With our all-inclusive package, we take care of all aspects of travel planning including booking flights and transfers.

Our extensive contacts include forestry organizations, accommodation providers and hunting outfitters, so we can design your trip to suit your needs and hunting wishes.

As a premium hunting trip provider, we place a lot of value on the highest quality and complete customer satisfaction in everything we do. To book your trip, please contact us. We can provide you with current information and quotes, plus advise you in detail about all travel and hunting-related matters.



Legend

-  Good physical condition required
-  Can be combined with a beach holiday
-  Suitable for families

Blaser Safaris GmbH

Europastraße 1/1, A-7540 Güssing
Austria
+43 (0) 33 22–429 63 0
info@blaser-safaris.com
www.blaser-safaris.com



Discover more hunting
adventures here!

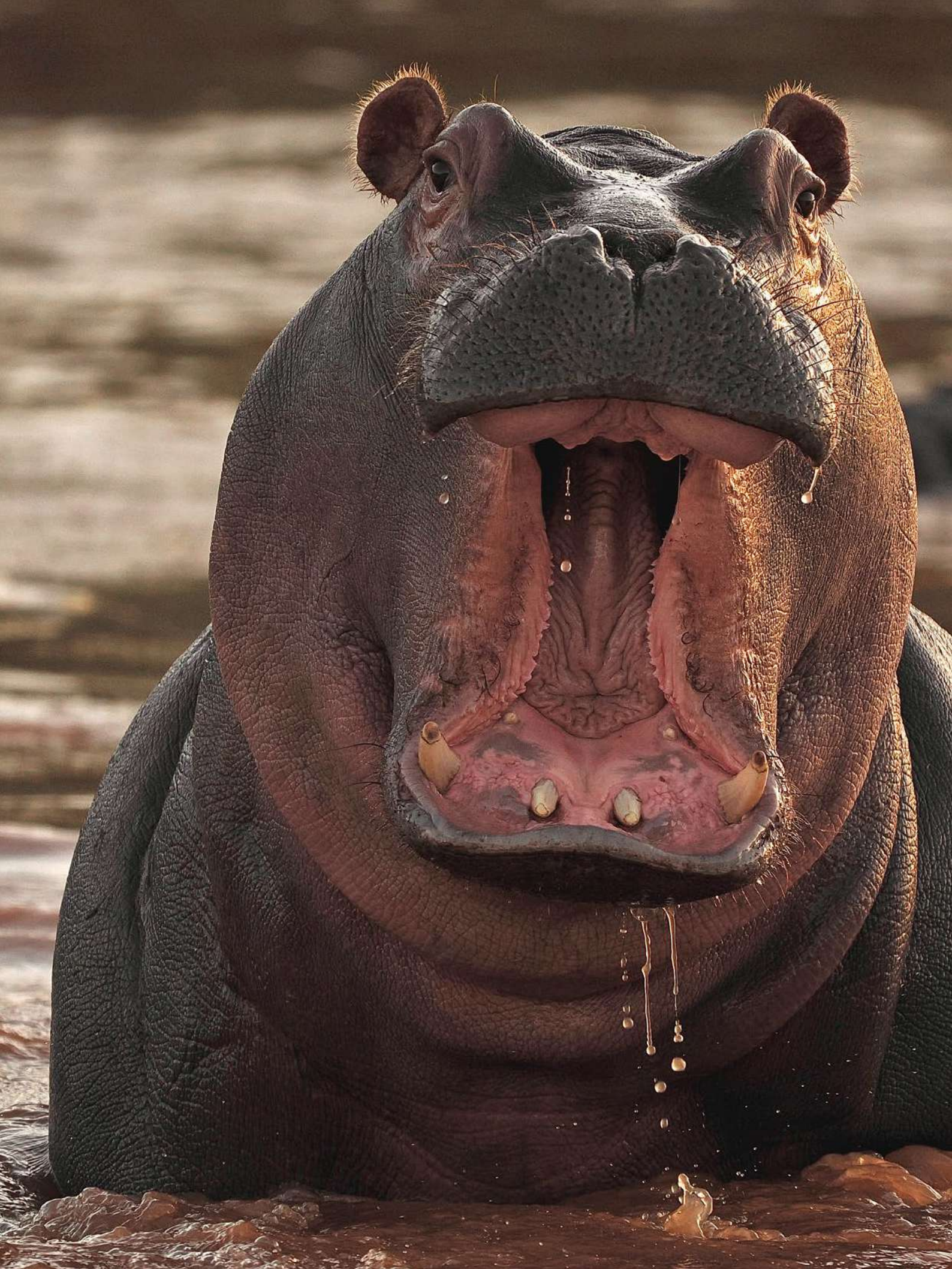



LIVING TO HUNT

We would like to thank all our hunters for taking part in the photo shoots.

Subject to technical changes, errors and color variations. Models can vary from country to country.

Blaser hunting rifles, ammunition and silencers are distributed exclusively through authorized Blaser dealers and are sold only to legal permit holders.

Please understand the legal regulations for the usage of silencers and thermal clip-on devices in your area and note that not every country allows their use.

Blaser GmbH
88316 Isny im Allgäu
Germany
www.blaser.de

Stay in touch!
Get the latest news and most recent developments by email:
sign up today for our Blaser newsletter at
www.blaser.de

© Blaser 2024

